



## INSTRUCTIONS FOR USE

# CH180RFWIFI

WIRELESS TOUCHSCREEN  
PROGRAMMABLE THERMOSTAT  
WITH WIFI CONNECTION



**FANTINI COSMI S.p.A.**

Via dell'Osio, 6 20090 Caleppio di Settala, Milano - ITALY  
Tel. +39 02 956821 | Fax +39 02 95307006 | info@fantinicosmi.it  
www.fantinicosmi.it

Thank you for purchasing a **FANTINI COSMI S.p.A.** product.  
 Read this instructions manual carefully and always keep it handy for any consultation.

This documentation reflects the specific product features; however, due to regulatory or commercial developments, customers are advised to check for the availability of updates to this documentation on the website FANTINI COSMI S.p.A. : [pdf.fantinicosmi.it](http://pdf.fantinicosmi.it)

## OPERATION

The CH180RFWIFI is a programmable thermostat with WiFi connection for direct control or control through APP Intellieclima + for Smartphones and Tablets of the wireless multi-zone temperature control system.

It monitors the various zones in the home, communicating with the CH120RF room thermostats and the O60RF wireless radiator actuators, with the CH175 boiler actuators or zone solenoid valve.

This system uses a program that allows you to set and edit as needed the temperature, humidity and time profiles for each zone.

It is equipped with a room temperature and humidity sensor, also performing the function of a zone heating, cooling and humidity control, commanding the O60RF and CH175 actuators.

It can also manage an auxiliary electrical device (for example an irrigation, ventilation, curtain, etc. system) with ON/OFF control through an outside CH175.

It has an internal configurable relay and users can view the energy consumption of the entire system via the intuitive graphics on its white backlit, positive LCD touchscreen.

CH180RFWIFI can communicate directly with 15 wireless devices (thermostats, actuators) and can manage up to 8 zones. In total, the network can be connected to a maximum of 114 devices.

**NOTE:** wireless transmission toward other devices occurs maximum within 2 minutes.

## MULTI-ZONE SYSTEM

The multi-zone system allows users to manage different temperature and humidity levels within the same home.

The values of each zone are set on the master CH180RFWIFI and modified locally by one or more devices installed inside the rooms. Communication between all the devices occurs via radio waves.

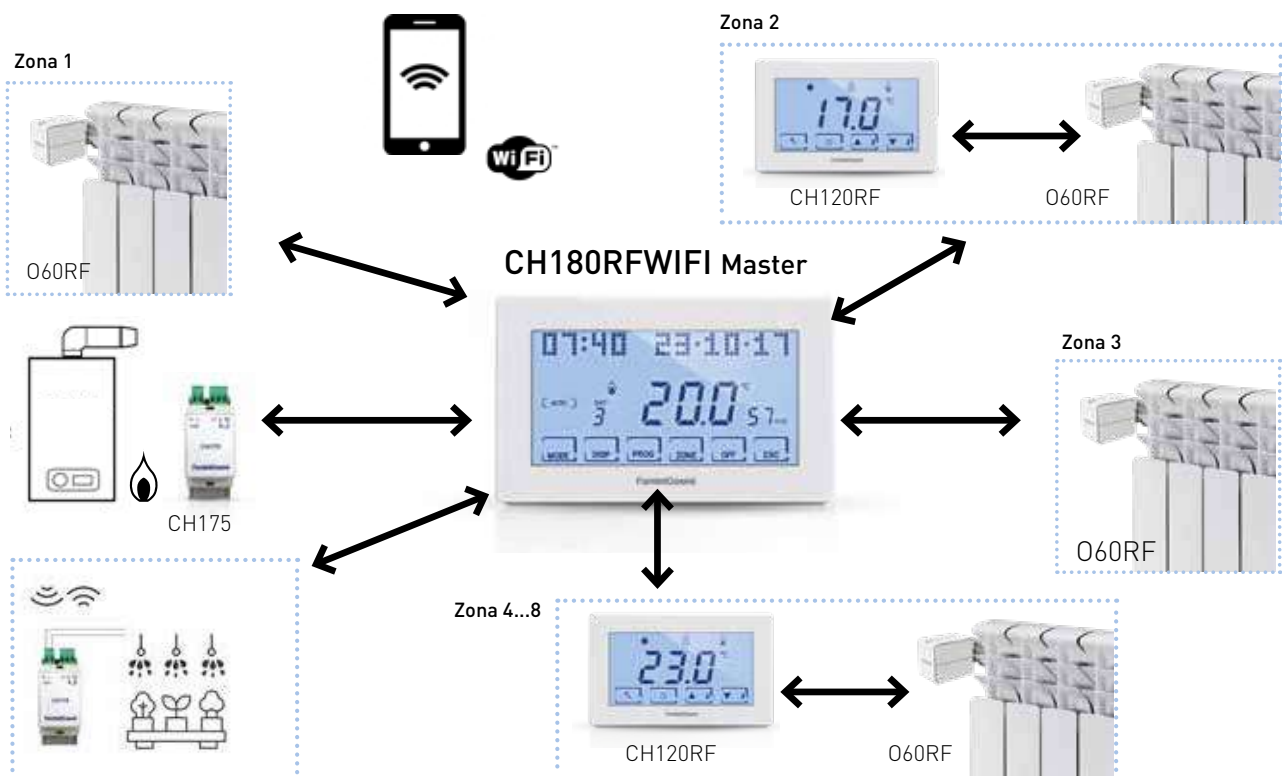

Once powered, the “MASTER” CH180RFWIFI must be included in the Intellicomfort+ system wireless network. This operation requires use of the configurator (code 1590880) which provides the operating instructions through its display. When requested by the message on the display, you must move the tip of the configurator toward the point indicated on the device to be configured to perform touch recognition.

For further details, please see the Intellicomfort+ system installation manual.



## DESCRIPTION OF DISPLAY KEYS

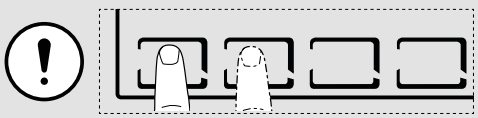

The first press of any touch button allows you to activate the functions of the buttons themselves and to light up the display.

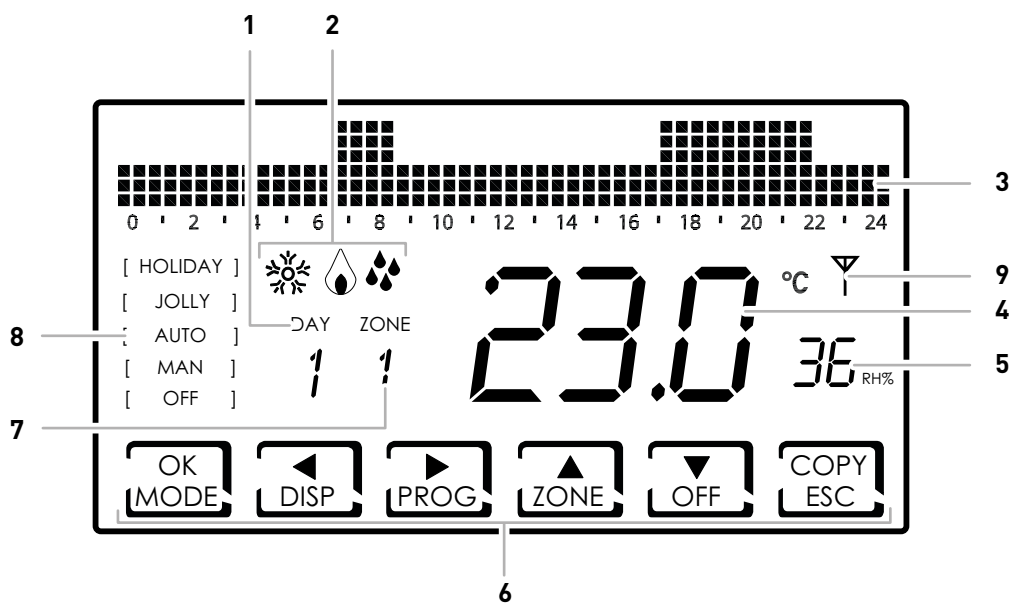

1	Day of the week
2	Activation status: heating, cooling or dehumidification
3	Bar graph for viewing messages and daily programming
4	Measured room temperature (Celsius/Fahrenheit)
5	Measured humidity
6	Multi-function touch icons
7	Zone
8	Operating mode
9	Various faults icon

The function of the multi-function keys varies depending on the situation and is described by the symbol which appears on the display near the key itself.

## TECHNICAL FEATURES

Temperature adjustment scale	2 - 40°C, increase 0.1°C
Measurement scale/room T display	- 50 - + 50°C
Relative humidity adjustment scale	30 - 70%, increase 0.1°C
Measurement scale/room relative humidity display	0 - 100%, increase 1%
Power supply	230V 50 Hz
Type of output	1 relay with potential-free change-over contact (COM/NA/NC) 3 screw terminals (closed + open)
Relay contact range	5(3)A 250 Vca
Type of action	1BU (micro connection)
Software	class A
Minimum adjusting differential	0.3 - 5 K
Thermal gradient of reference	4 K/h
Maximum room temperature	45°C
Storage temperature	-10°C - +60°C
WIFI connection	2.4 GHz (802.11 b/g/n)
Router communication port	1080
Transmission and reception frequency	868 MHz
Maximum radio frequency power transmitted	< 10 mW
Electric insulation	Double insulation
Protection rating	IP40
Pollution rating	2
Pulse voltage	4000V
Wall or	recessed mounting
Dimensions	127 x 82 x 24 mm
Compliant with standards	<ul style="list-style-type: none"> <li>■ EN 60730-1 and second parts</li> <li>■ Directive 2014/53/EU (RED)</li> </ul>
ErP classification	<ul style="list-style-type: none"> <li>■ ErP Class IV; 2% [Reg. EU 811/2013 - 813/2013]</li> <li>■ Class VIII; 5% when used with O60RF actuators to create three or more heating zones.</li> </ul>

## PACKAGE CONTENTS

- 1 programmable thermostat
- 2 screws for fixing on recessed mounting box 503 with American pipe thread 6/32UNC (approx. Ø 3.5mm)
- 1 quick guide

## Summary

<b>OPERATION .....</b>	<b>2</b>	<b>7 - ADVANCED FUNCTIONS (PROG) .....</b>	<b>24</b>
<b>MULTI-ZONE SYSTEM.....</b>	<b>2</b>	7.1 - DISPLAY ON TIME.....	24
<b>DESCRIPTION OF DISPLAY KEYS .....</b>	<b>3</b>	7.2 - DISPLAY INTENSITY .....	24
<b>TECHNICAL FEATURES .....</b>	<b>4</b>	7.3 - DAYLIGHT SAVINGS TIME.....	25
<b>PACKAGE CONTENTS .....</b>	<b>4</b>	7.4 - ANTIFREEZE TEMPERATURE .....	25
<b>1 - INSTALLATION .....</b>	<b>6</b>	7.5 - RELATIVE HUMIDITY.....	26
<b>2 - ELECTRICAL CONNECTION.....</b>	<b>8</b>	7.6 - RELAY FUNCTION.....	26
<b>3 - QUICK GUIDE FOR PROGRAMMING (PROG) .....</b>	<b>9</b>	7.7 - ZONE NAMES.....	27
3.1 - DATE AND TIME SETTING .....	9	7.8 - OFFSET .....	28
3.2 - WINTER/SUMMER SETTING .....	10	7.9 - DIFFERENTIAL MANAGEMENT.....	28
3.3 - HOURLY PROGRAMMING SETTING (PROFILE).....	10	7.10 - CELSIUS / FAHRENHEIT.....	29
3.4 - AUX1 SETTING .....	12	7.11 - LANGUAGE .....	29
3.5 - SETTING KEYBOARD LOCK WITH PASSWORD .....	12	7.12 - EXTERNAL PROBE .....	30
<b>4 - OPERATION (MODE) .....</b>	<b>14</b>	7.13 - COOL OFF .....	31
4.1 - OPERATING PROGRAMS .....	14	7.14 - AUX1.....	32
4.2 - SELECTING THE OPERATING PROGRAM.....	15	7.15 - ZONE DEU.....	33
4.3 - SETTING "AUTO" PROGRAM .....	16	7.16 - WIFI.....	34
4.4 - SETTING GENERAL "JOLLY" PROGRAM .....	17	7.17 - INFORMATION .....	35
4.5 - SETTING ZONE "JOLLY" PROGRAM .....	17	7.18 - RESETTING DEFAULT PARAMETERS.....	35
4.6 - SETTING "AUTO" and "HOLIDAY" PROGRAM TEMPERATURE.....	18	<b>8 - REMOTE PROGRAMMING VIA APP.....</b>	<b>36</b>
4.7 - SETTING "MANUAL" and "JOLLY" PROGRAM TEMPERATURE ..	18	8.1 - WIFI ACTIVATION .....	36
<b>5 - DISPLAYING PARAMETERS (DISP).....</b>	<b>19</b>	8.2 - INSTALLATION PROCEDURE .....	37
5.1 - SEASON .....	19	8.3 - CONNECTION PROBLEMS .....	38
5.2 - EXTERNAL PROBE .....	19	<b>9 - DISPOSAL.....</b>	<b>39</b>
5.3 - HOURS OF USE.....	20	<b>10 - GENERAL WARRANTY CONDITIONS .....</b>	<b>39</b>
5.4 - WIFI STATUS .....	21		
5.6 - RSSI .....	22		
5.5 - SERIAL NUMBER.....	22		
5.7 - FAULTS .....	23		
<b>6 - LOCK FOR SCREEN CLEANING (ESC) .....</b>	<b>23</b>		

## 1 - INSTALLATION



**ATTENTION!**

Installation must be carried out by qualified personnel in compliance with the requirements concerning installation of electrical devices.



**ATTENTION!**

Make sure that the power supply is disconnected before performing installation.

The CH180RFWIFI programmable thermostat must be wall or recess mounted, with 3 modules or round box, at a height of about 1.5 m from the floor, in a position suitable to correctly detect the room temperature.

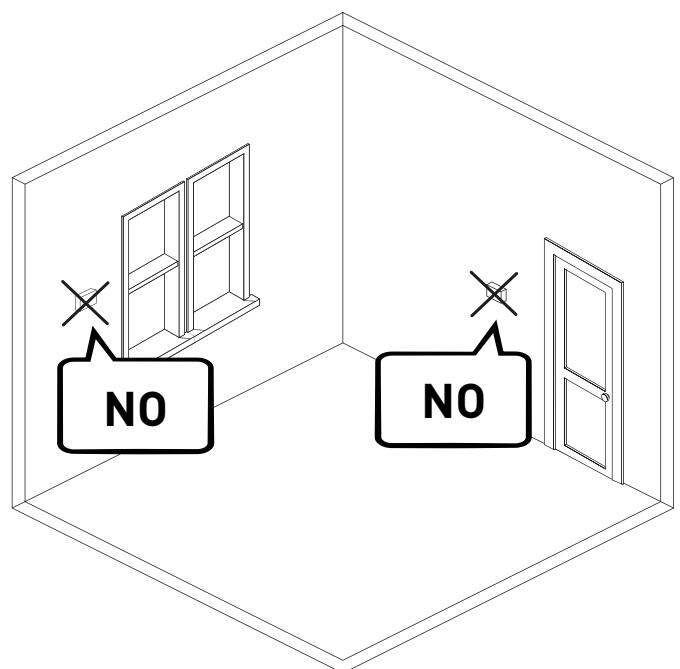
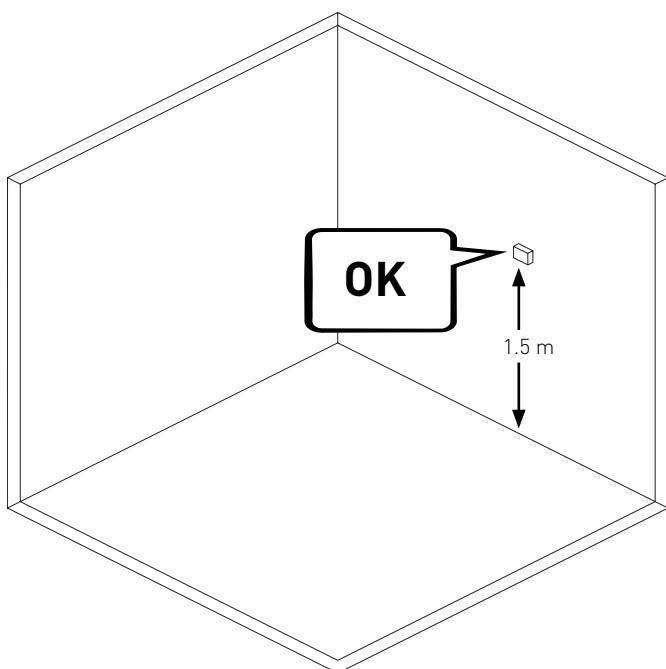
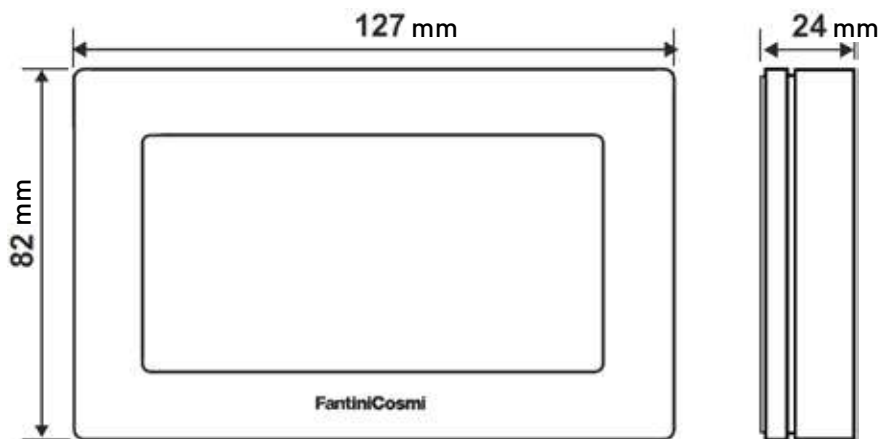

Pry the back panel off the body by applying pressure to the specific groove at the bottom.

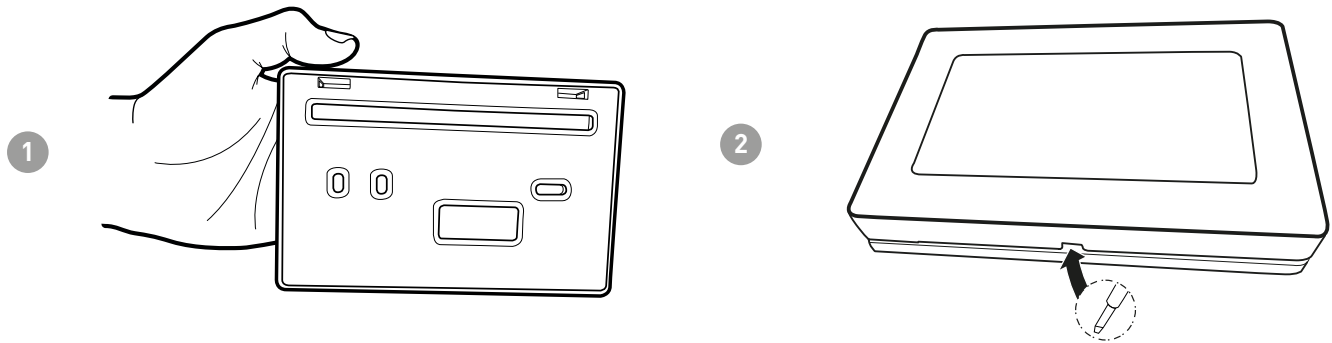

Remove the insulating protection by unscrewing the specific waterproof screw.

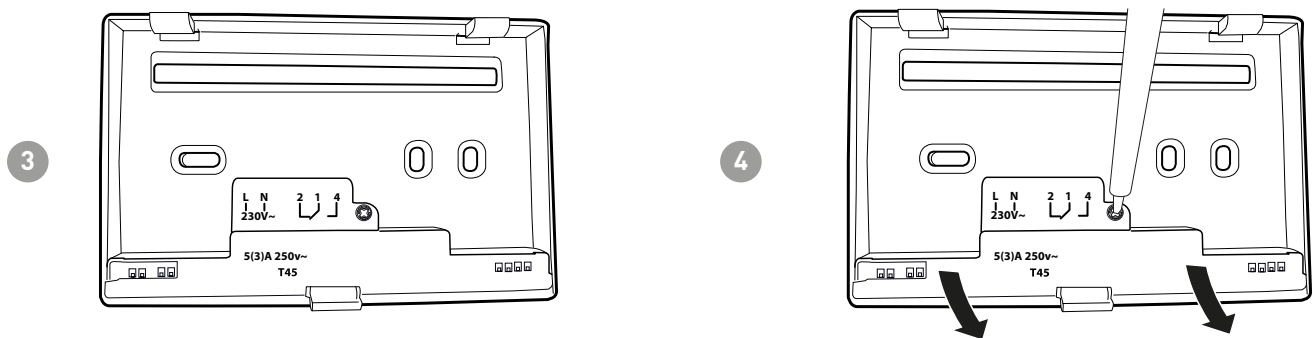

Make the electrical connections (refer to the "Electrical connections" paragraph) and secure the panel to the wall with the supplied screws.

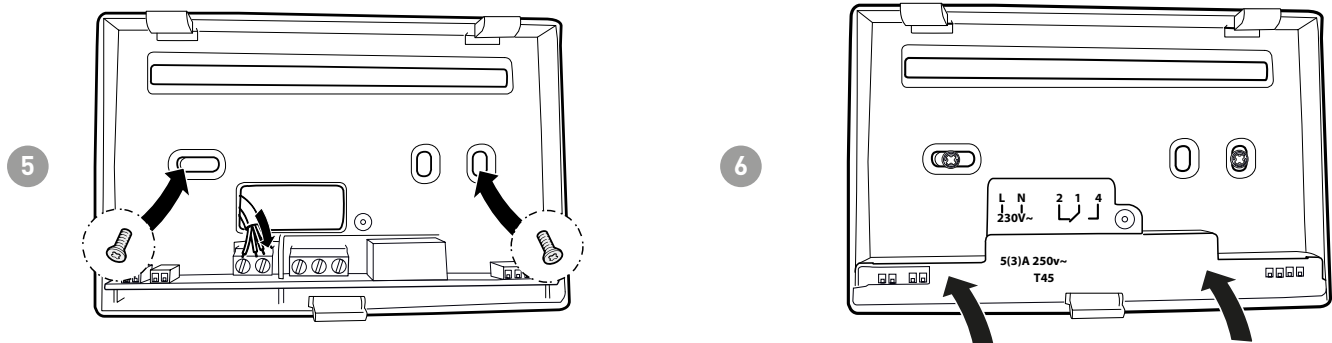

Tighten the screw shown and hook the body onto the panel on the wall.

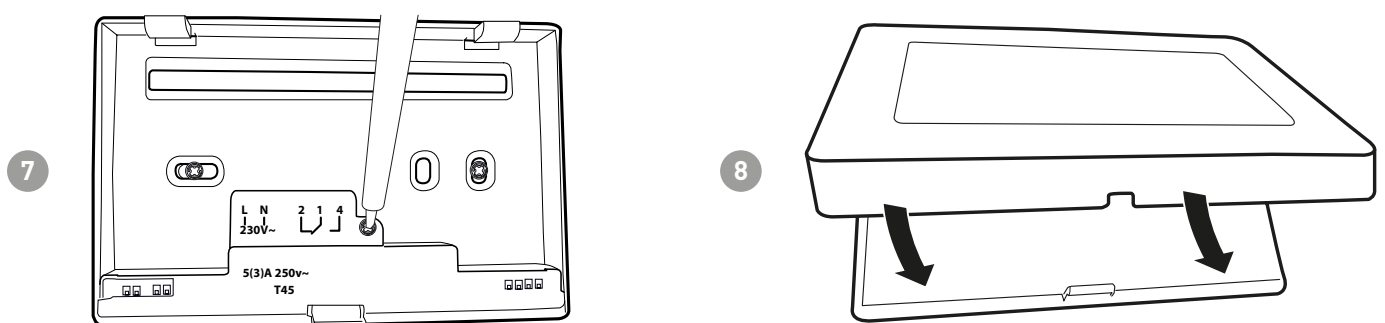

## 2 - ELECTRICAL CONNECTION



**ATTENTION!**

Electrical connections must be made by qualified personnel.



**ATTENTION!**

Electrical connection operations must be done with the system's power disconnected.

Electrical connections must be made referencing the following diagram.

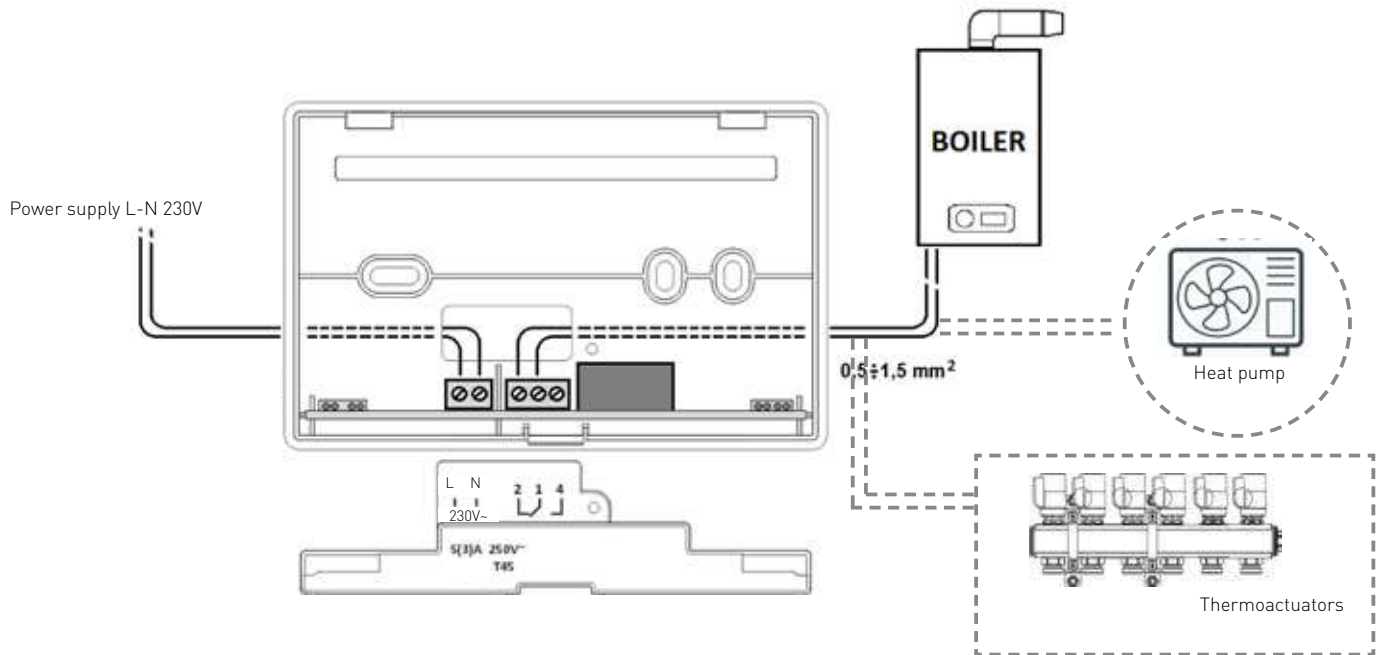





### 3 - QUICK GUIDE FOR PROGRAMMING (PROG)

The first time any touch key is pressed has no effect, but only activates the functions of the buttons themselves and lights up the display.

After 30 seconds of no interaction, the display goes back to the main screen.

 = allows you to CONFIRM and EXIT from the current screen

 = allows you to PROGRAM

#### 3.1 - DATE AND TIME SETTING

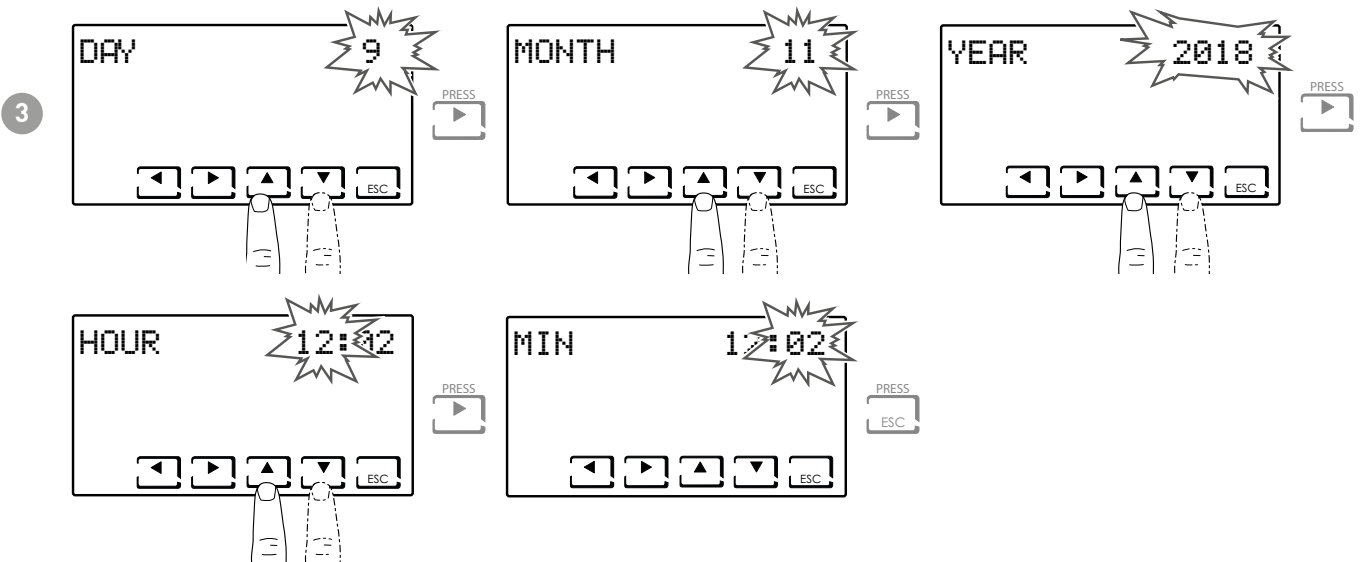
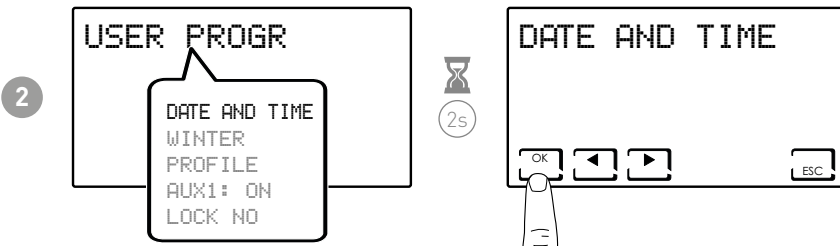
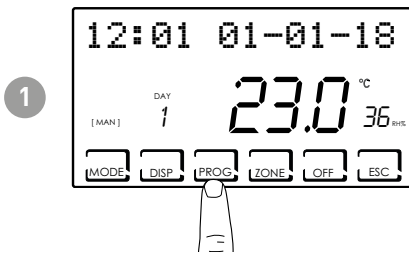

Note:  always allows you to go back to the previous page.

### 3.2 - WINTER/SUMMER SETTING

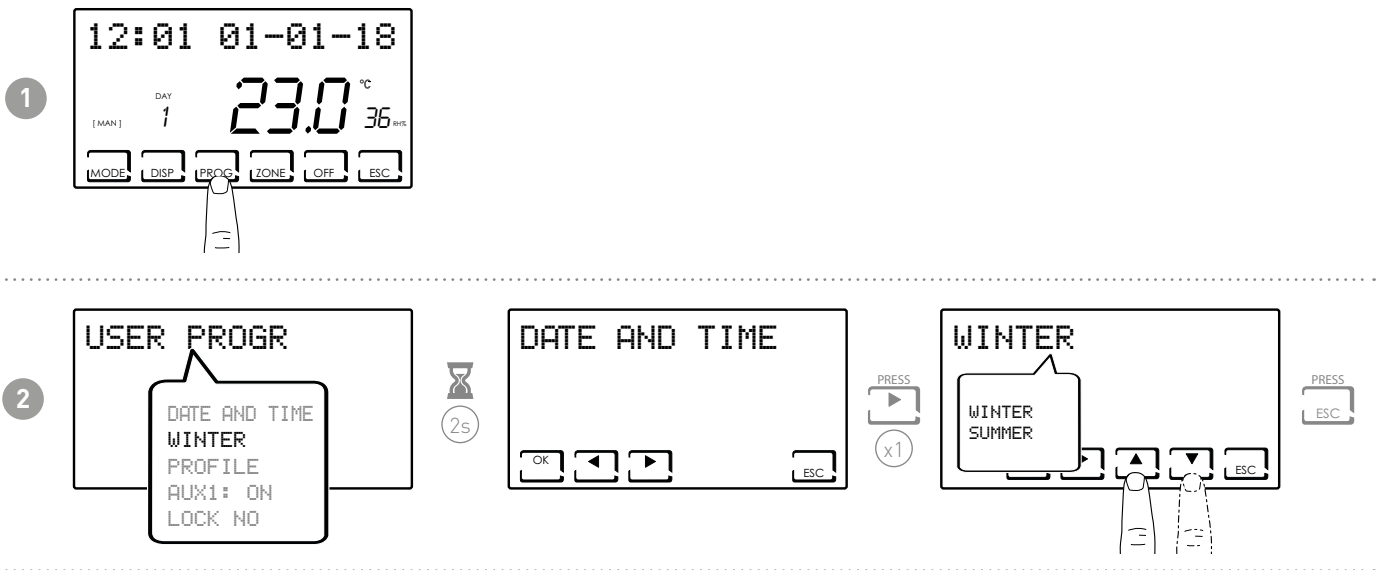

### 3.3 - HOURLY PROGRAMMING SETTING (PROFILE)

The profiles are set based on whether WINTER or SUMMER mode was previously selected.

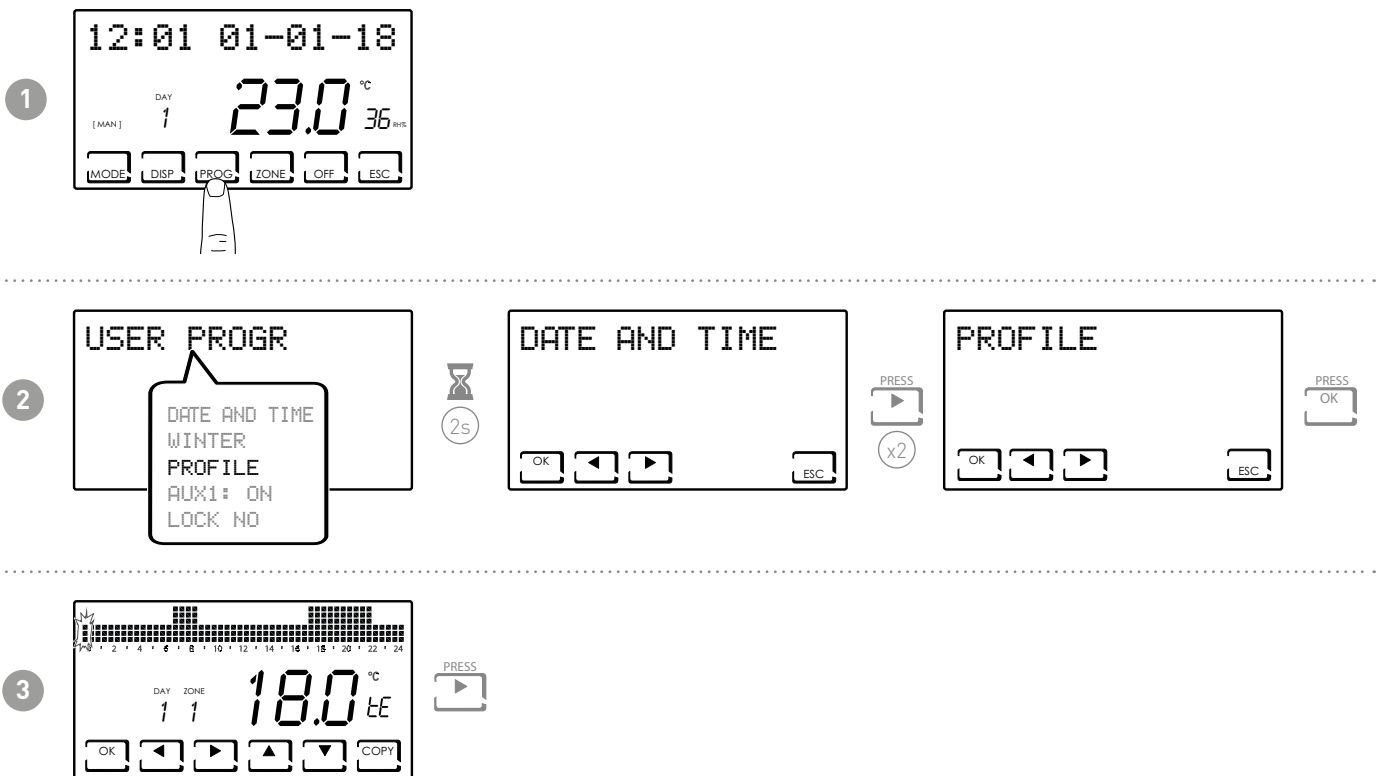

**Note:** pressing ◀ or ▶ allows you to move within the hours.

4

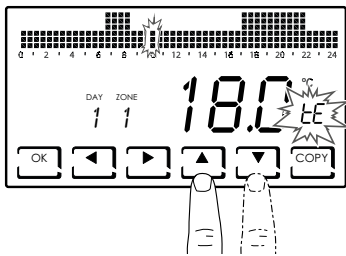

Pressing ▲ or ▼ allows you to select the profile depending on the time.

**SETTABLE PROFILES:**

- tC (comfort) = SUMMER, WINTER
- tE (economy) = SUMMER, WINTER
- tA (antifreeze) = for WINTER only
- OFF = for SUMMER only

In winter tE < tC; in summer tC < tE.

**Note:**

- Pressing OK allows you to go to the next day.



- Pressing COPY allows you to copy the temperature profile being displayed to the following day.



- Pressing and holding OK allows you to go to the next zone.

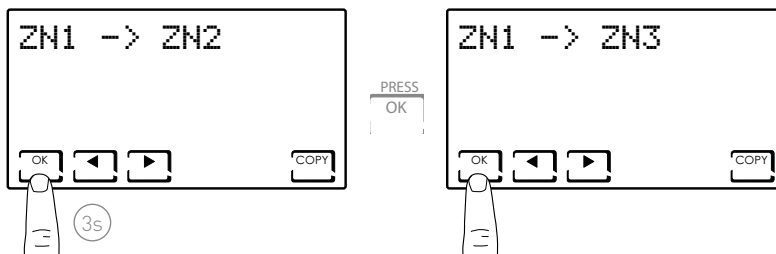

- Once you have reached DAY H (HOLIDAY), pressing OK allows you to copy the profile of the whole zone set to the next one.

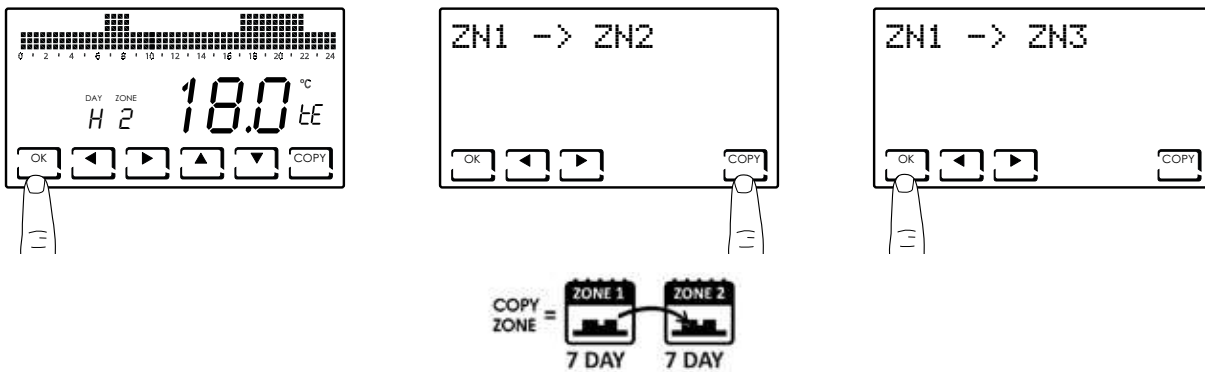

### 3.4 - AUX1 SETTING

It is possible within the multi-zone system to autonomously manage an additional ON/OFF device (for example irrigation, shutter darkening, outside lights, fan, air conditioner, etc. systems).

You must have a CH175 connected to this device and it must be configured as an auxiliary AUX1 actuator.

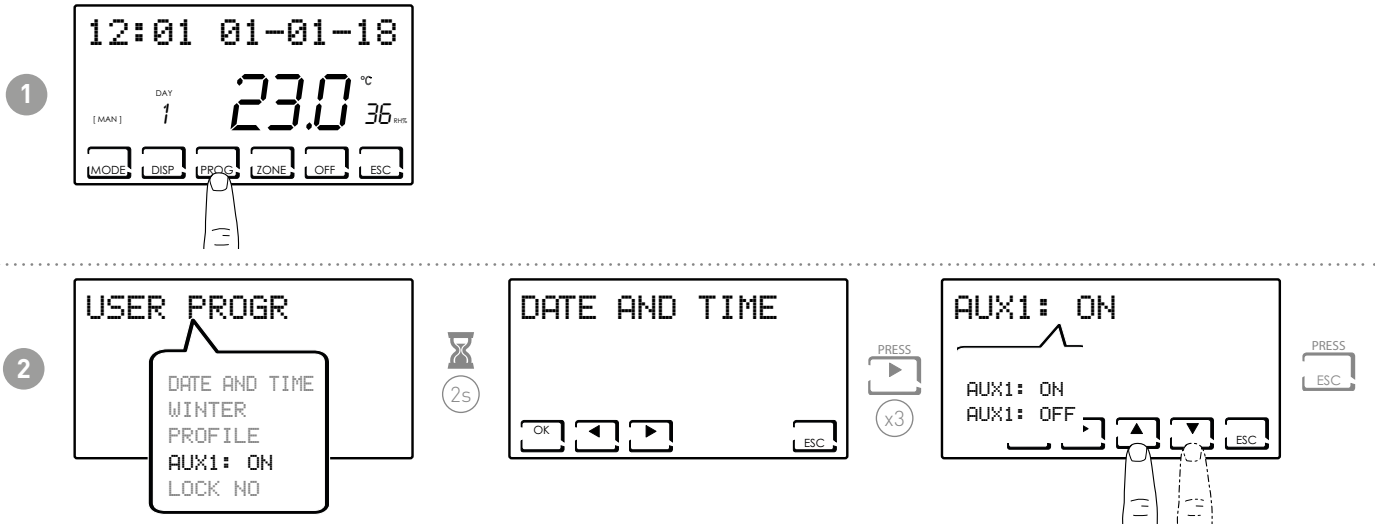

**Note:** if the symbol ! appears on the screen, it means that the command was set with the hourly profile and therefore cannot be edited on this page. To edit it, follow the instructions in paragraph 7.

### 3.5 - SETTING KEYBOARD LOCK WITH PASSWORD

Lets you lock the CH180RFWIFI keyboard and any CH120RF included in the network through a 3-digit numerical code. It works only once, then it must be enabled again.

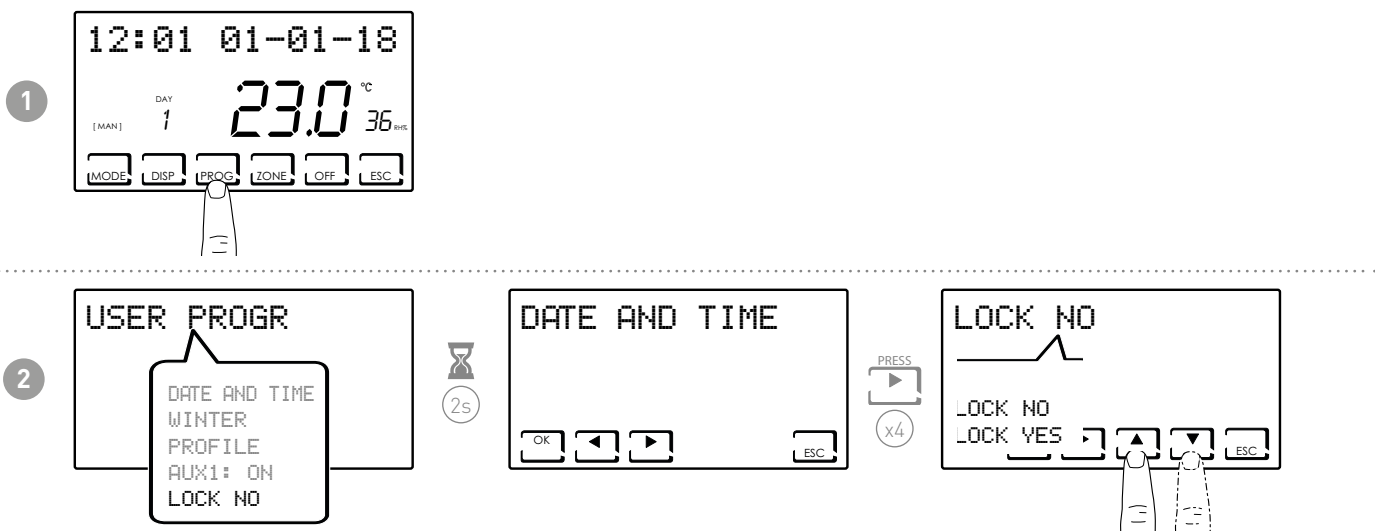

**Note:** selecting LOCK YES displays the OK key. Then follow the procedure described in points 3 and 4.

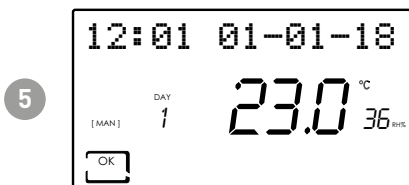
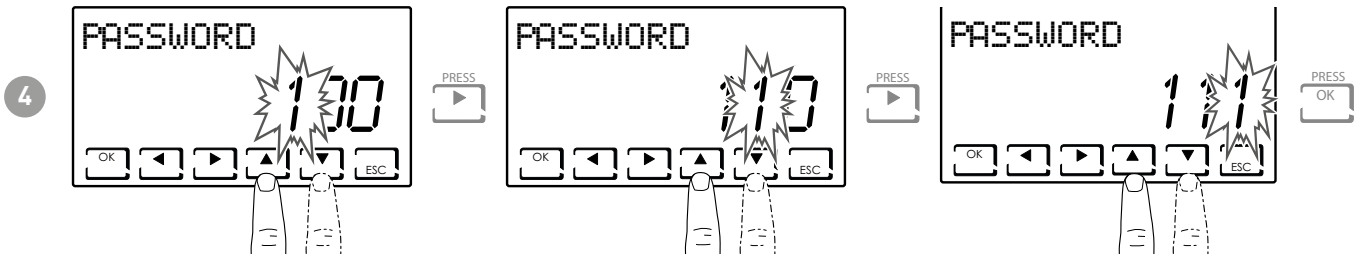
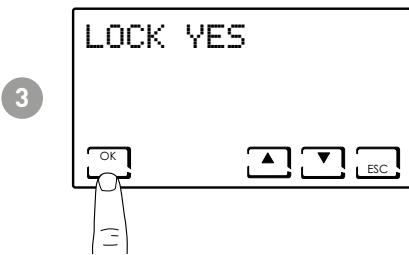

When the keyboard is locked, you can only press the OK key.  
Pressing OK allows you to enter the set password and unlock the keyboard.

**Note:** with the KEYBOARD LOCK WITH PASSWORD function running, the CH120RF keys connected to the MASTER CH180RFWIFI will also be locked.  
A blackout does not reset the password.

## 4 - OPERATION (MODE)

On CH180RFWIFI, it is possible to activate and display the main operating modes either for the whole system or for a single zone.

To select a zone, exit from STAND-BY mode and press the ZONES key until the selected zone number is displayed.

To exit from the zone, press the ESC key, or else the CH180RFWIFI will go back to the main screen after 30 seconds.

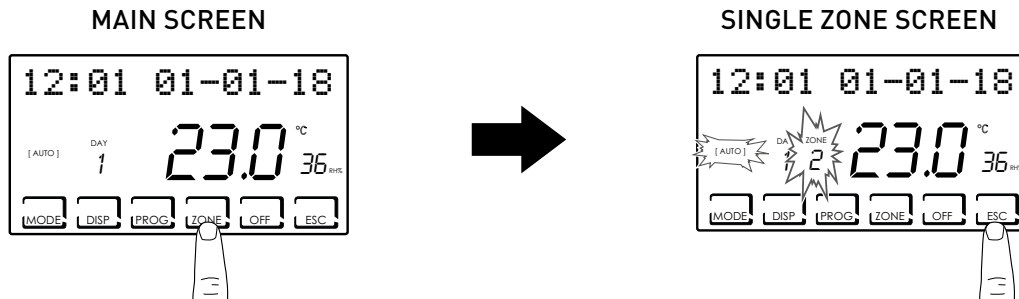

### Note:

- If the LOCAL SET message appears in a zone, it means that the set-point has been changed for a finite time for the CH120RF of the indicated zone (see TEMPORARY MODIFICATION in the CH120RF manual).
- If WAIT appears in a zone, this means that no data relating to the selected zone has arrived after the creation of the network.
- Any function set from the MAIN SCREEN affects the entire multi-zone system, while any function set in a SINGLE ZONE only affects the related area.

## 4.1 - OPERATING PROGRAMS

The CH180RFWIFI programmable thermostat has different operating modes, called programs.

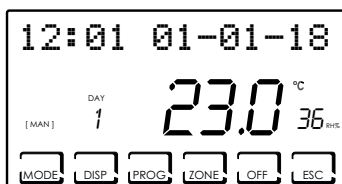

### [ MAN ]

- MANUAL PROGRAM

The device regulates room temperature using a set temperature specified on a case-by-case basis, for an unlimited amount of time until another program is selected.

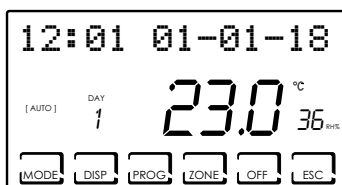

### [ AUTO ]

- WEEKLY PROGRAM

The device manages the temperatures set based on the hourly programs on a weekly profile. You can set the following temperature levels: tC, tE, tA/ OFF (every half hour).

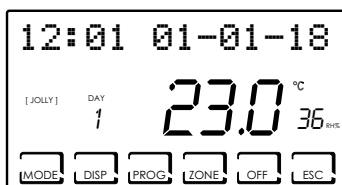

### [ JOLLY ]

- TEMPORARY PROGRAM

The device manages the system using a temperature that can be set over a variable amount of time (you set the hour and the day up to when you wish to keep the set temperature).

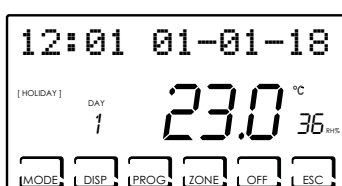

### [ HOLIDAY ]

- HOLIDAY PROGRAM

The device manages the system through an extra daily profile (in the event you stay home for a holiday). You can set two temperature levels: tC, tE, tA, OFF (every half hour).

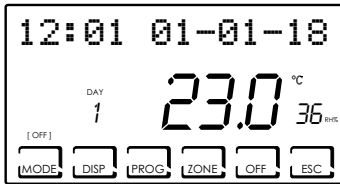

■ SYSTEM OFF or ANTIFREEZE PROGRAM

Press the OFF key to switch off the system. The antifreeze temperature is maintained during WINTER mode.

If the OFF key is pressed again in SYSTEM OFF mode, the system will return to the previously set operating mode.

## 4.2 - SELECTING THE OPERATING PROGRAM

The programs are selected in cyclical order.

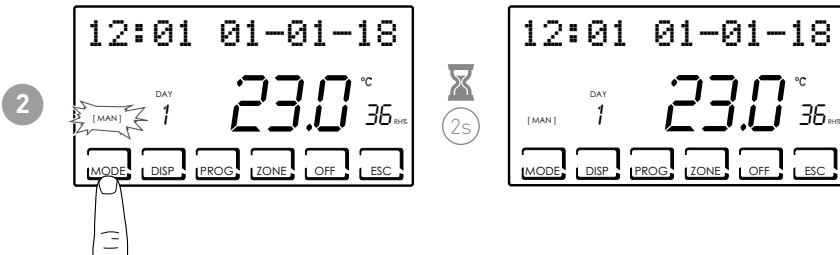

**Note:** press the MODE key to select from the [MAN] - [AUTO] - [JOLLY] - [HOLIDAY] operating modes in cyclical order. If MODE is pressed from the main screen, all zones will be in the mode selected.

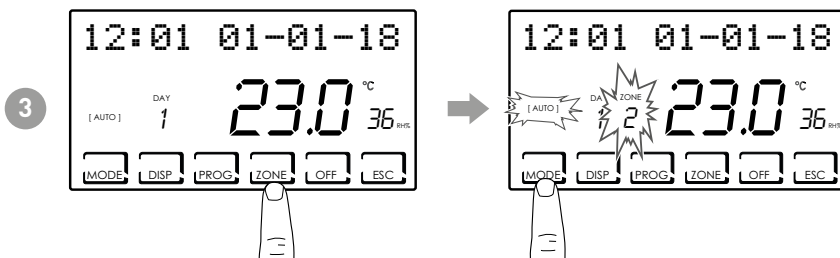

**Note:** press ZONE and then press MODE to set the operating mode for every single associated zone. The name of the operating mode is displayed in square brackets (e.g. [AUTO]).

**DISP** Pressing the DISP key allows the user to view some parameters set based on the active operating program.

### 4.3 - SETTING “AUTO” PROGRAM

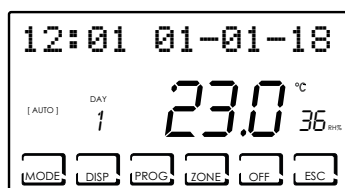

The device manages the temperatures set based on the hourly programs on a weekly profile. You can set the following temperature levels: tC, tE, tA/OFF (every half hour).

The CH180RFWIFI has weekly pre-set profiles in both winter and summer, but the user can edit them. See par. 3.3, page 10.



## 4.4 - SETTING GENERAL "JOLLY" PROGRAM

The device manages the system using a temperature that can be set over a variable amount of time (you set the hour and the day up to when you wish to keep the set temperature).

From the main screen, press MODE until JOLLY appears. The JOLLY TOT screen is displayed.

Press OK and use the ◀▶ and ▲▼ arrows to set the time (with 30 min. resolution) and the day until which you want to maintain the set temperature.

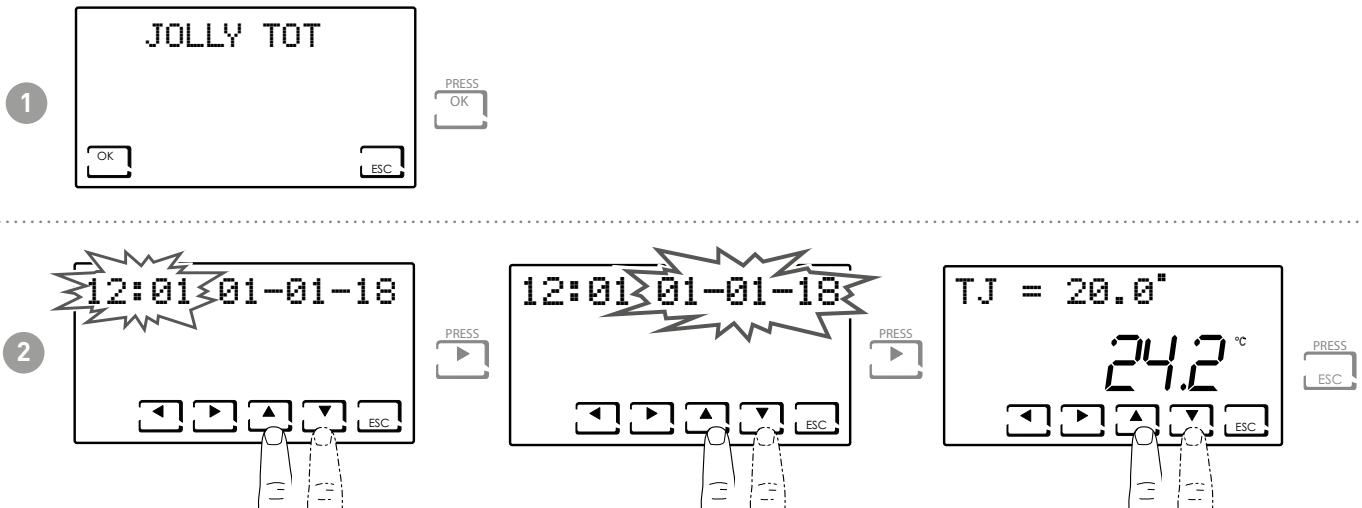

Set the time and day until you which you want to maintain the set temperature.

At the end of JOLLY mode, the programmable thermostat will return to the previously set operating status.

## 4.5 - SETTING ZONE "JOLLY" PROGRAM

Press ZONE to select the desired zone and then press MODE until JOLLY appears. The JOLLY screen is displayed.

Press OK and use the ◀▶ and ▲▼ arrows to set the time (with 30 min. resolution) and the day until which you want to maintain the set temperature.

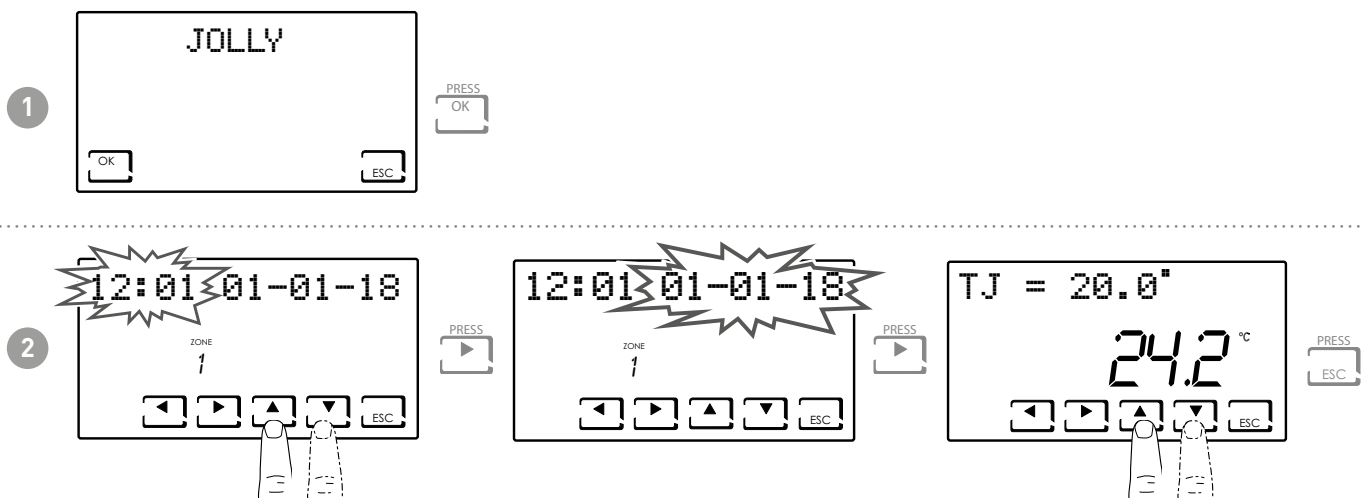

Set the time and day until you which you want to maintain the set temperature.

## 4.6 - SETTING “AUTO” and “HOLIDAY” PROGRAM TEMPERATURE

If the device is in AUTO or in HOLIDAY, you can set a tCOMF (comfort temperature) and tECO (economy temperature) temperature value between 2° and 40°C.

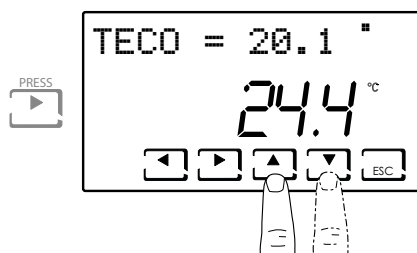
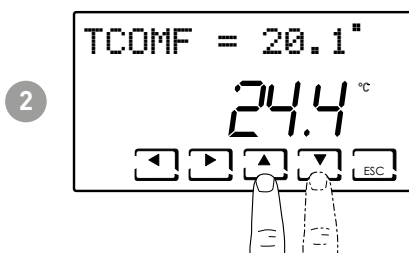
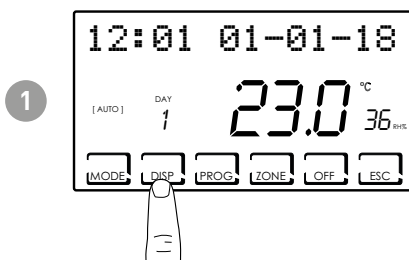

TCOMF > TECO (WINTER)  
TCOMF < TECO (SUMMER)

**Note:** the same procedure applies to single zones.

## 4.7 - SETTING “MANUAL” and “JOLLY” PROGRAM TEMPERATURE

If the device is in MAN or in JOLLY, you can set a TMAN and TJ temperature value between 2° and 40°C.

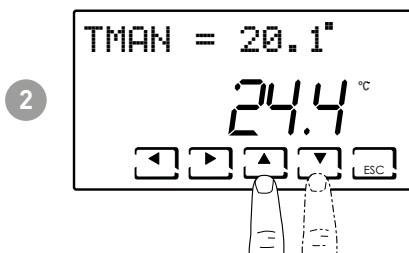
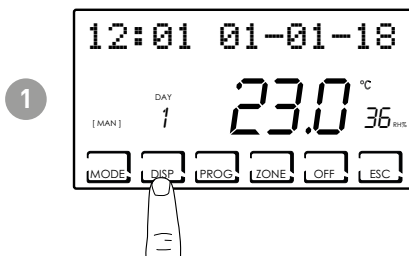

**Note:** the same procedure applies to single zones.

## 5 - DISPLAYING PARAMETERS (DISP)

Press the DISP key to view the most significant parameters cyclically.

### 5.1 - SEASON

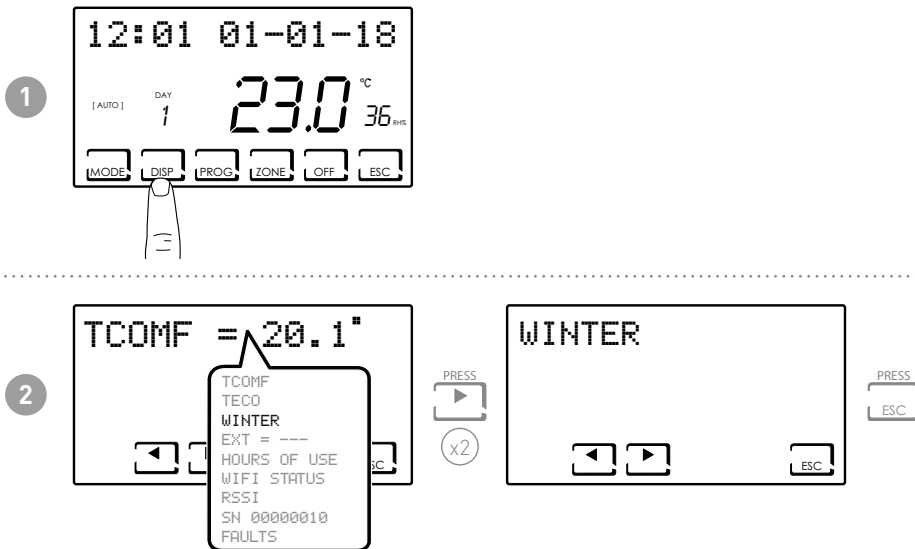

### 5.2 - EXTERNAL PROBE

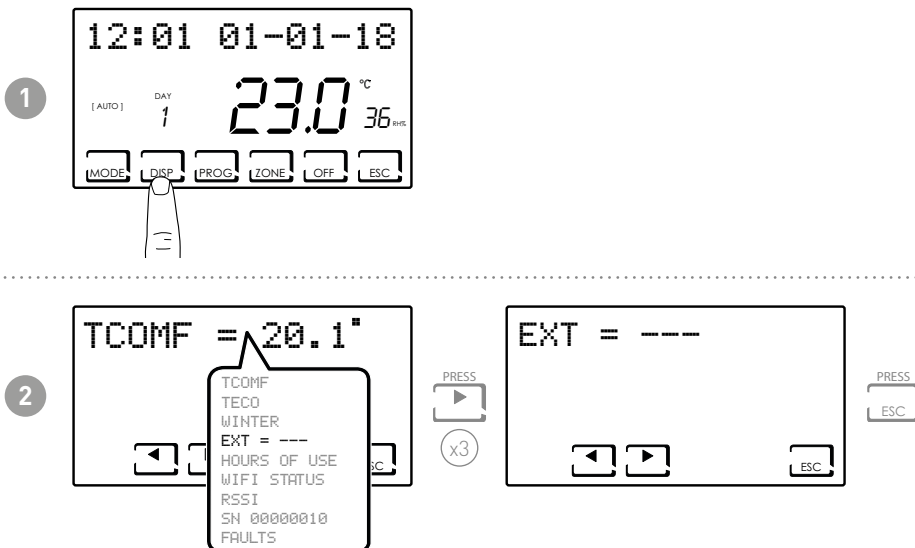

**Note:** "----" will be displayed if no external probe is present.

### 5.3 - HOURS OF USE

The programmable thermostat records the total consumption of the heating and cooling hours.

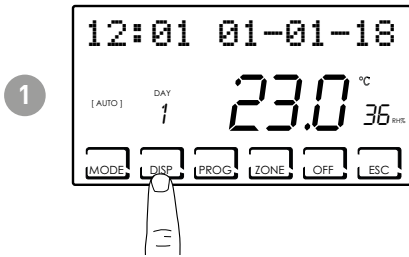

**Note:** it is possible to vary the use statistics by

- PREVIOUS DAY = total operating hours on the previous day
- CURRENT MONTH = total operating hours in the current month
- PREVIOUS MONTH = total operating hours on the previous month
- CURRENT YEAR = total operating hours in the current year
- TMAX = maximum room temperature measured from the previous day
- TMIN = minimum room temperature measured from the previous day
- RESET

Press OK on the CURRENT MONTH, PREVIOUS MONTH and CURRENT YEAR screws to view a chart with the details of use (shown below).

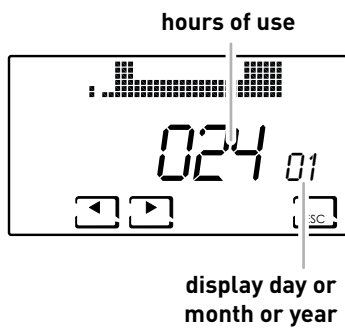

Press ◀ or ▶ to move and view the day of the month (or month or year, depending on the page displayed) and hours of use.

## 5.4 - WIFI STATUS

Allows you to view the WiFi signal quality.

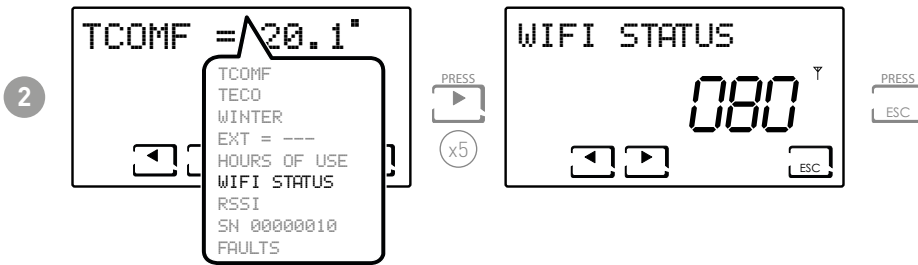
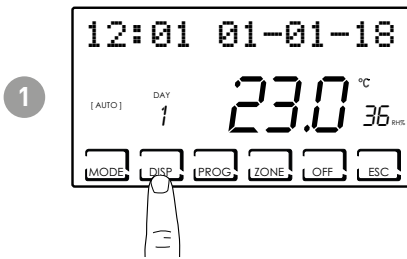

>90	50 - 90	30 - 50	<30
EXCELLENT signal	GOOD signal	LOW signal	POOR signal

**Example:**

WIFI STATUS = 80  
= Good Signal

If the icon is:

- STEADY ON = status is OK
- FLASHING ON = device cannot find the server
- OFF = the device is not connected to the router (OFF will appear on the display)

## 5.6 - RSSI

Displays the quality of the signal received from the devices connected directly to the programmable thermostat.

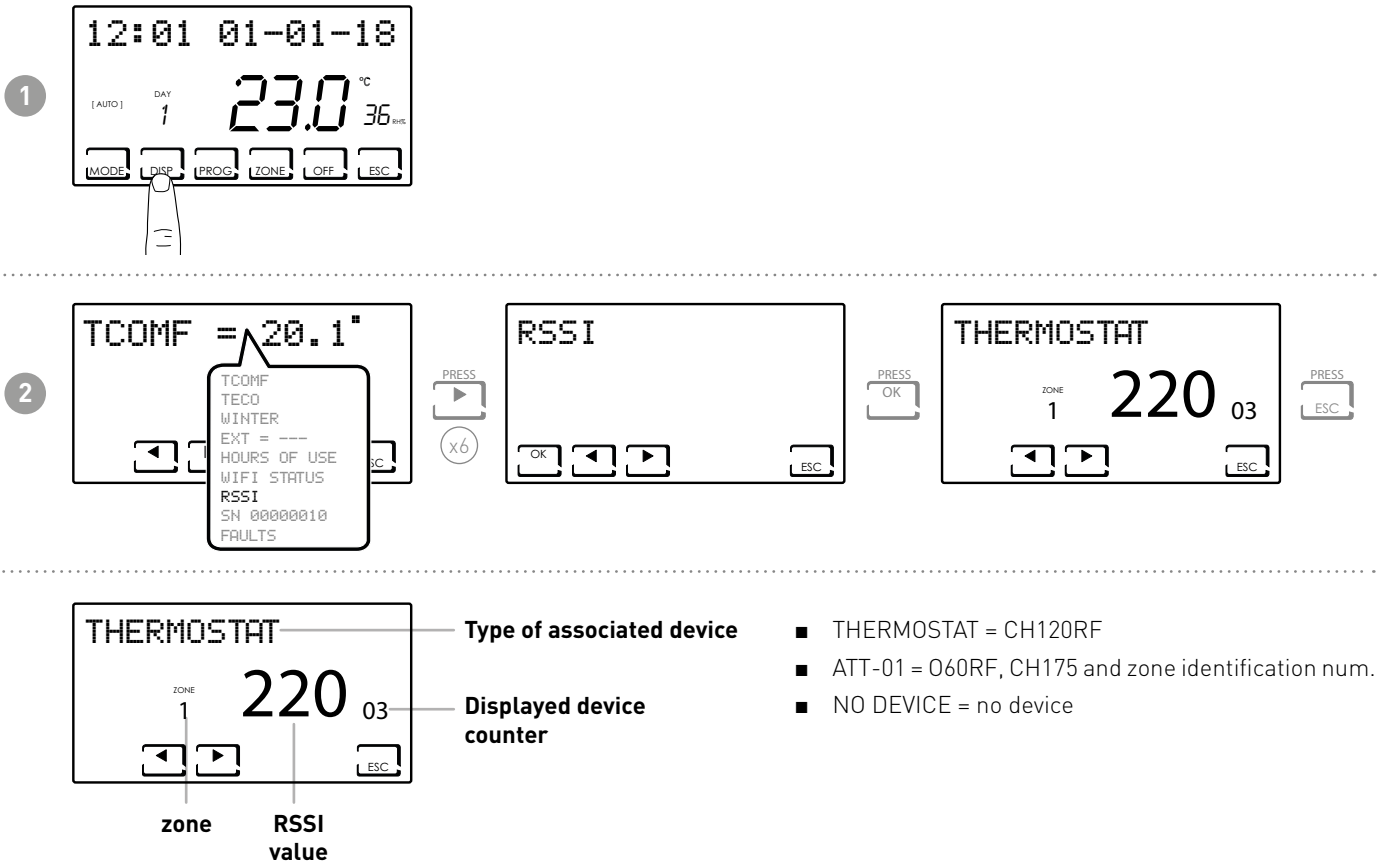

## 5.5 - SERIAL NUMBER

Allows you to view the device serial number.

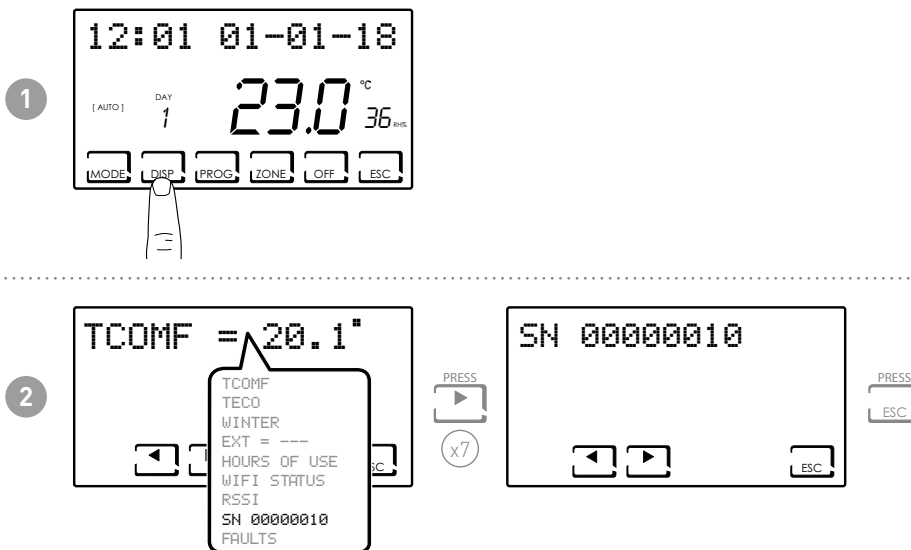

**Note:** this number identifies the single device and is used for WiFi activation via the "Intelliclimate+" app.

## 5.7 - FAULTS

Allows you to view the presence of any faults on the programmable thermostat.

The flashing  icon on the display indicates that a fault is present on one of the devices making up the multi-zone system.

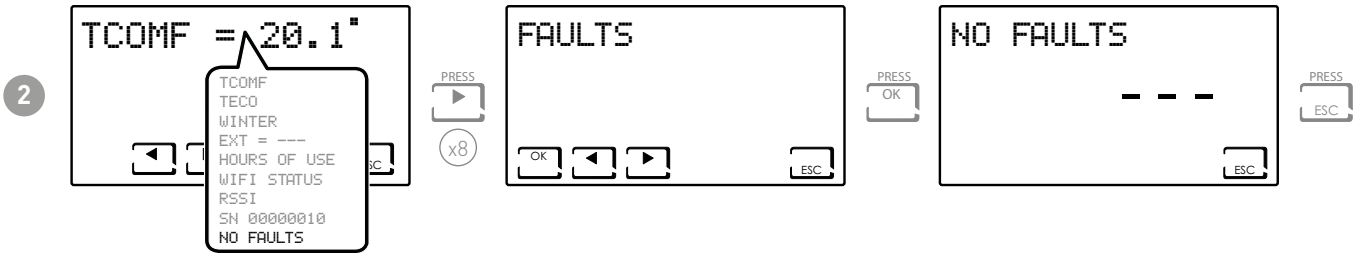
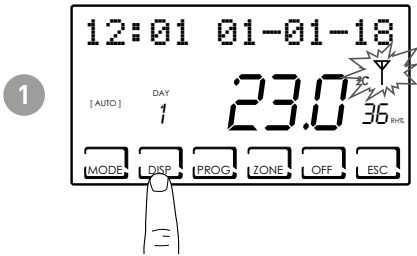

ERROR	DEVICE	FAULT	ACTION
020	O60RF	Incorrect assembly	Make sure that the head is mounted properly on the valve; contact technical support if the problem persists.
010/ 021/ 030	O60RF	Mechanical / electronic error	Contact technical support.
022	O60RF	Temperature reading error	Contact technical support.
040	O60RF	Low battery	Replace the batteries.
001	CH120RF	Low battery	Replace the batteries.
006	CH120RF	No radio communication	Replace the batteries; contact technical support if the problem persists.
050	O60RF	No radio communication	Replace the batteries; contact technical support if the problem persists.
050	CH175	No radio communication	Check the mains power supply; contact technical support if the problem persists.

## 6 - LOCK FOR SCREEN CLEANING (ESC)

Press ESC for 5 seconds. The message LOCKED will appear on the display for 30 seconds.

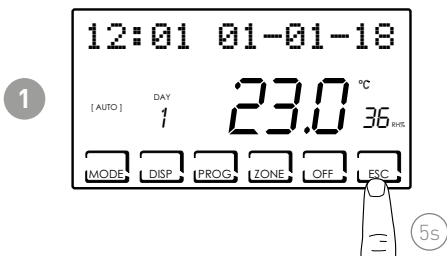

## 7 - ADVANCED FUNCTIONS (PROG)

Press and hold the PROG key for a few seconds to access ADVANCED PROGRAMMING.

### 7.1 - DISPLAY ON TIME

Allows you to adjust the display backlight time (with white light) from 5 to 30 seconds (default = 5s).

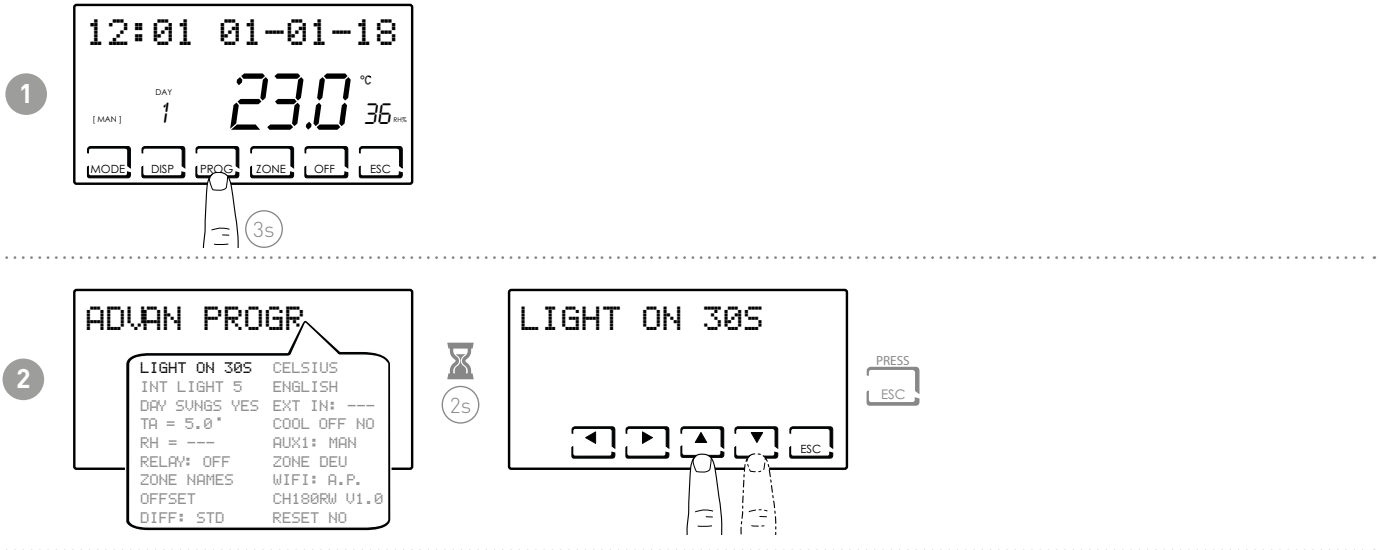

### 7.2 - DISPLAY INTENSITY

Allows you to modify the luminous intensity of the display on 10 levels + 0 Off (default = 5s).

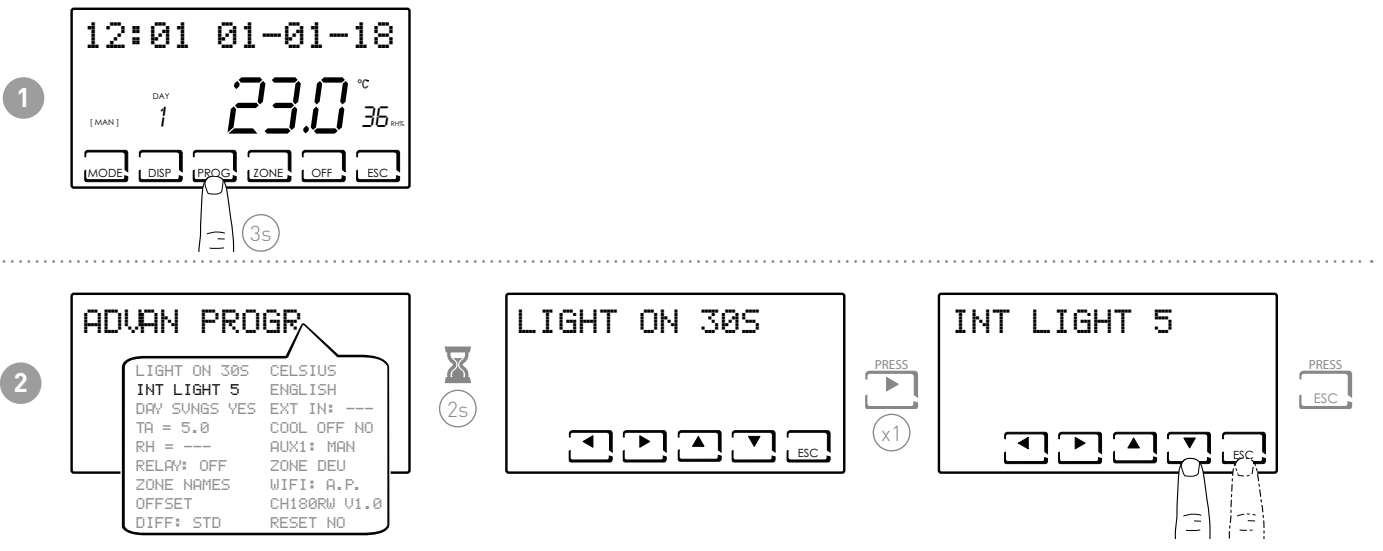



### 7.3 - DAYLIGHT SAVINGS TIME

Automatically selects the daylight saving time, applicable in European and some other countries. This allows you to automatically update the time at the time change (March and October) (default = YES).

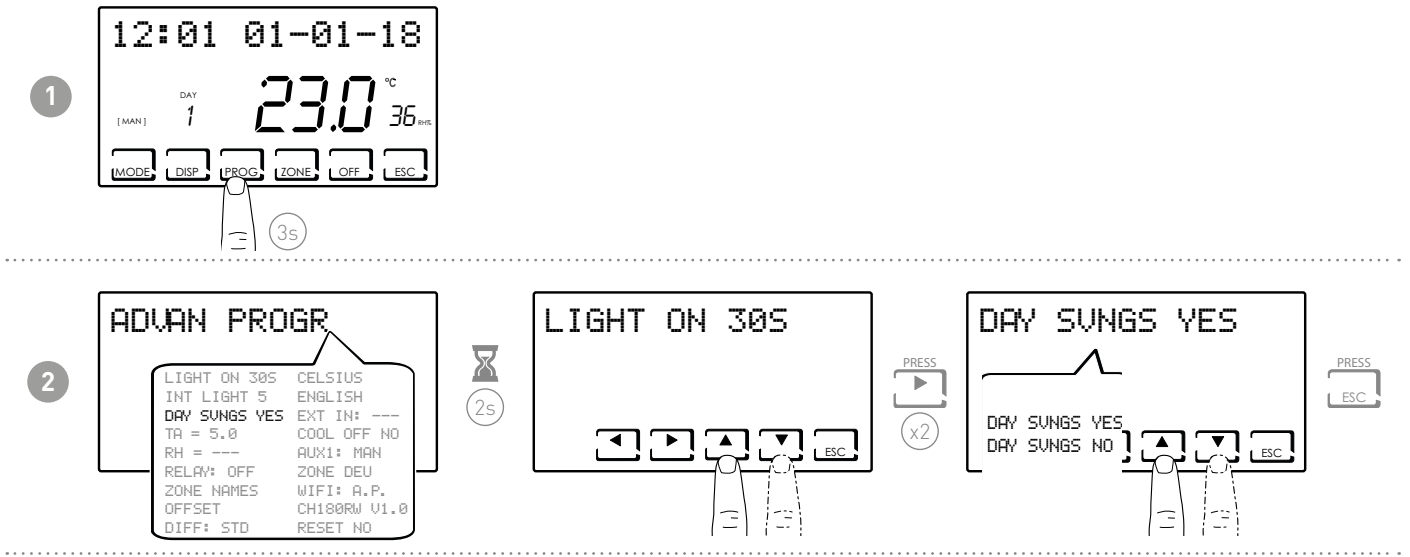

### 7.4 - ANTIFREEZE TEMPERATURE

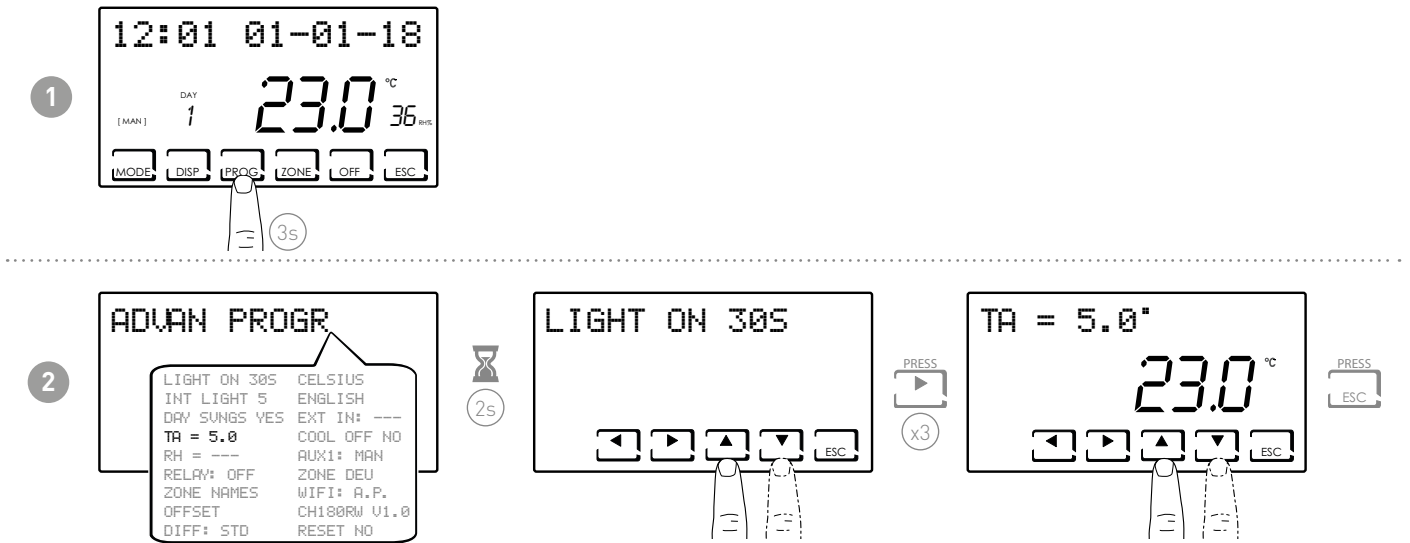

**Note:**

- The tA can be set from a range between 2.0 and 7.0 °C and an OFF value (default = 5.0°C).
- This function cannot be activated in SUMMER.

## 7.5 - RELATIVE HUMIDITY

This parameter allows you to set the relative humidity limit above which make a dehumidifier starts to operate.

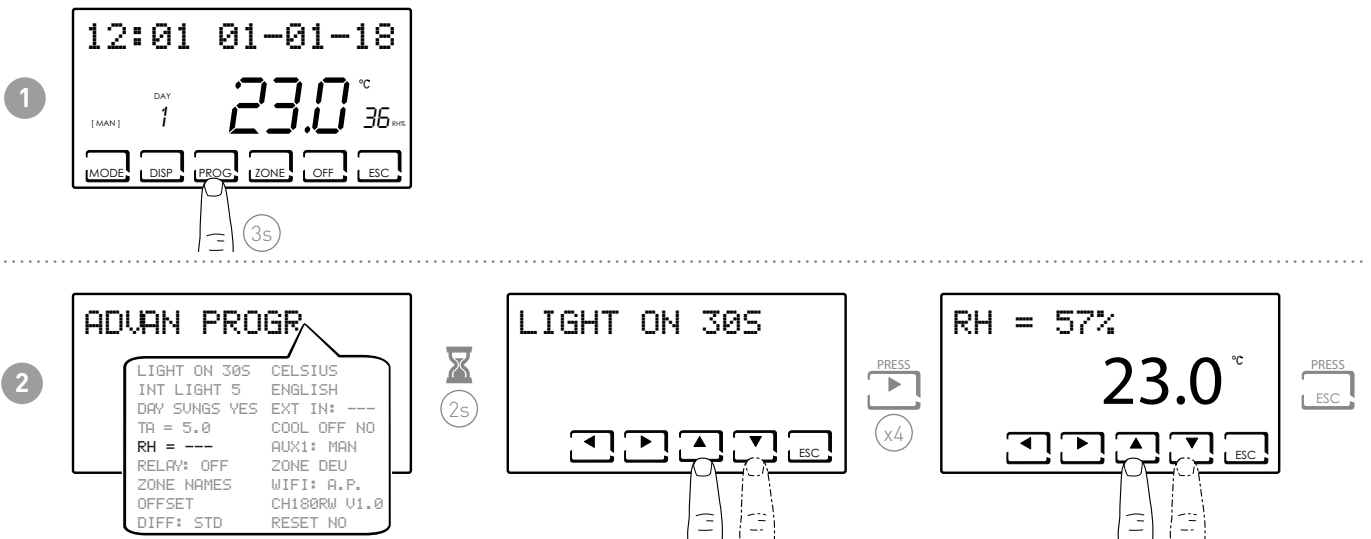

**Note:** this set-point value can be adjusted from 30% to 70%, or "----" not present (default = ---).  
This function cannot be activated in WINTER.

## 7.6 - RELAY FUNCTION

This parameter allows you to set the relay inside the programmable thermostat for various uses. The available functions are:

- OFF = always off because unused
- DEU.Z. = activation of a dehumidification unit only in zone 1
- RAF.Z = activation of a cooling unit only in zone 1
- RIS.Z = activation of a heating unit only in zone 1
- R.R.Z. = activation of a heating and/or cooling unit only in zone 1
- DEU.G. = activation of a general dehumidification unit
- RAF.G. = activation of a general cooling unit
- RIS.G. = activation of a general heating unit
- R.R.G. = activation of a general heating and/or cooling unit

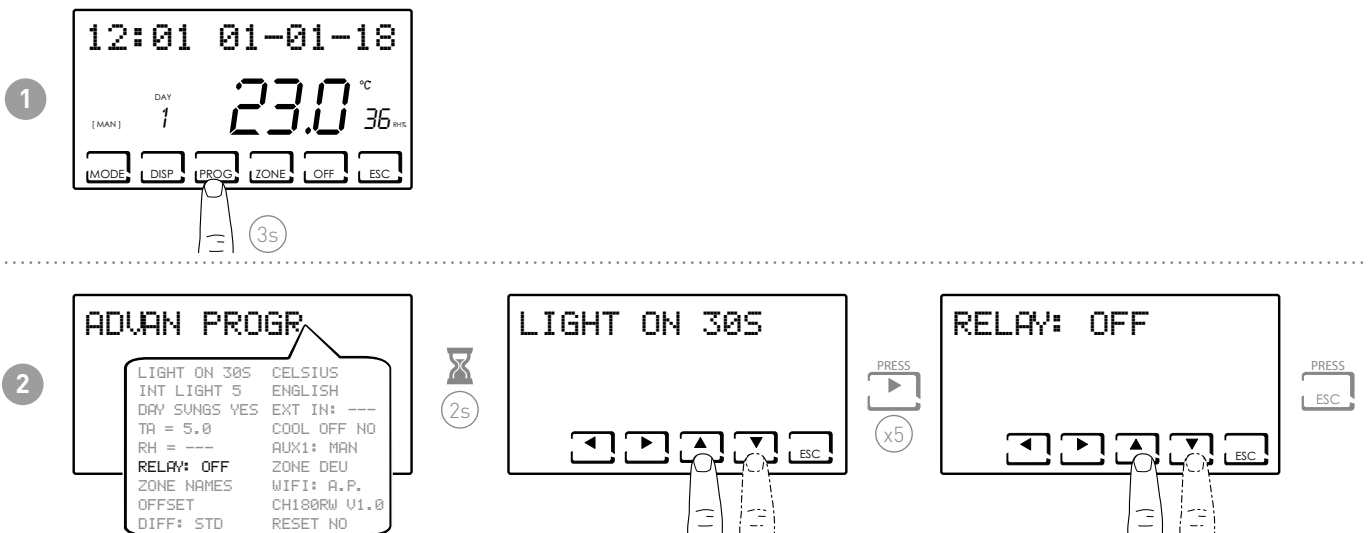

**Note:** the default setting is OFF.

## 7.7 - ZONE NAMES

Allows you to assign a name to each zone of the system.

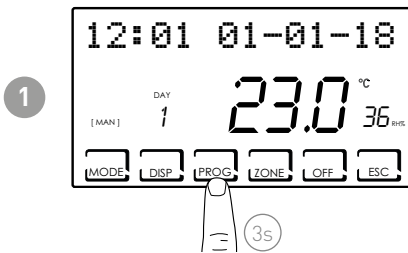

Press ◀ or ▶ to select the zone name.

Press ▲ or ▼ to assign a number to the selected name.

Example: Zone 1 = MASTER BEDROOM 1

The names of the zones range between:

- Master Bedroom
- Bedroom
- Living Room
- Kitchen
- Bathroom
- Entrance
- Hallway
- Attic
- Family Room
- Closet
- Guest Room
- Foyer
- Cellar
- Garage
- Laundry Room
- Boiler Room
- Day-time area
- Night-time area
- Floor
- Zone

## 7.8 - OFFSET

Allows to modify the temperature measured by CH180RFWIFI and by the heads O60RF which act as zone. Due to an incorrect wall installation or assembly of the heads on radiators located in non-ideal positions (behind walls, curtains or in crannies), the sensors might not indicate the correct temperature perceived by the devices. This function corrects the measured temperature for the selected zone by  $\pm 5.0$  °C (default = 0.0 °C).

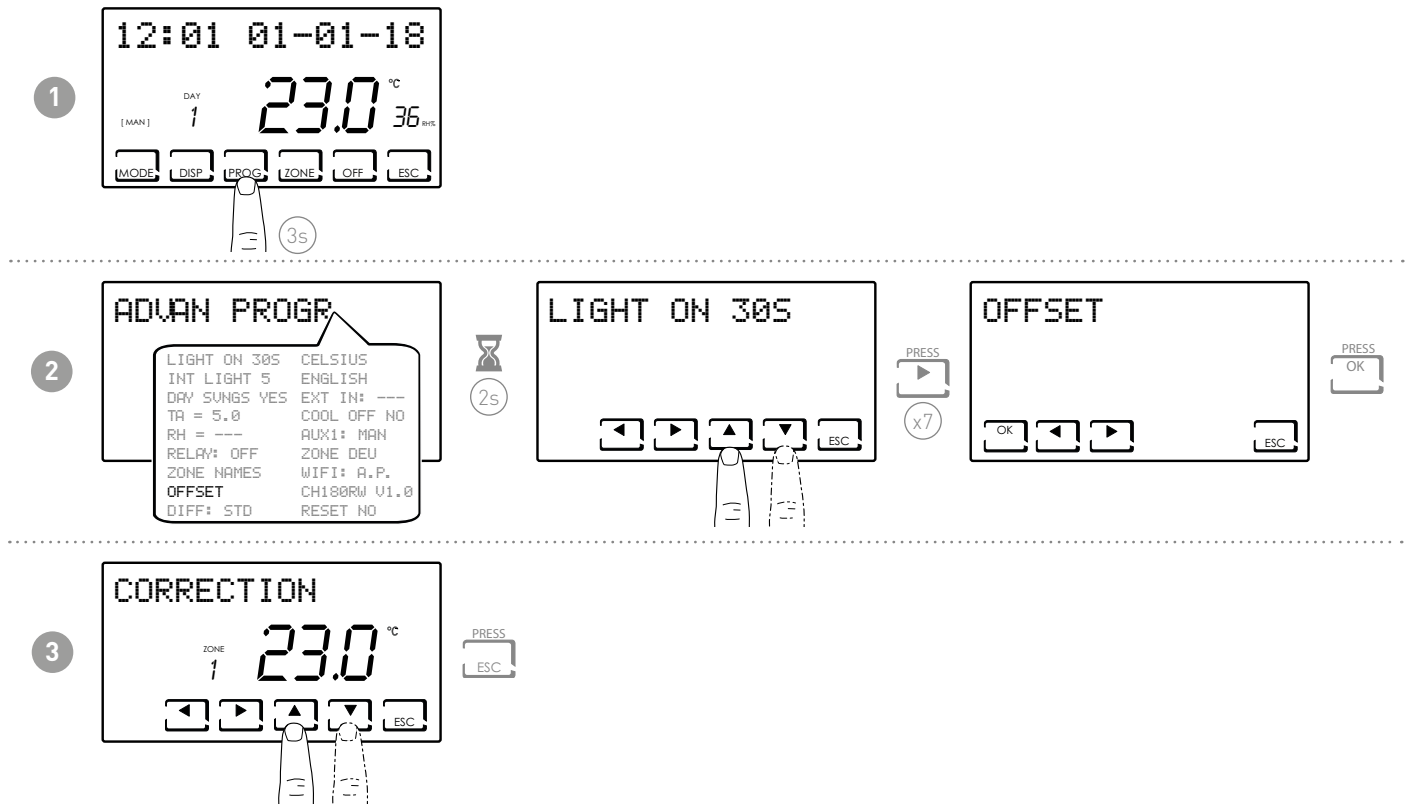

## 7.9 - DIFFERENTIAL MANAGEMENT

Allows you to manage the temperature difference between the OFF and ON status.

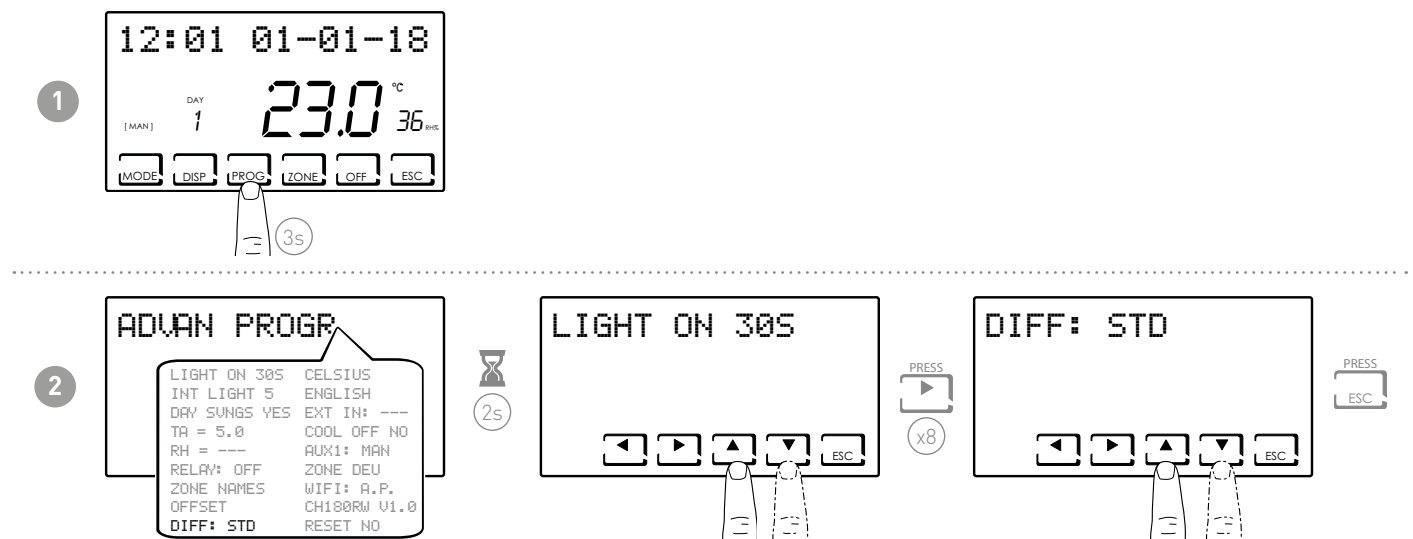

**Note:** the differential value can be set between 0.3 and 5.0, or STD standard (default = STD).

## 7.10 - CELSIUS / FAHRENHEIT

Allows you to choose the set the temperature display scale between degrees Celsius and degrees Fahrenheit.

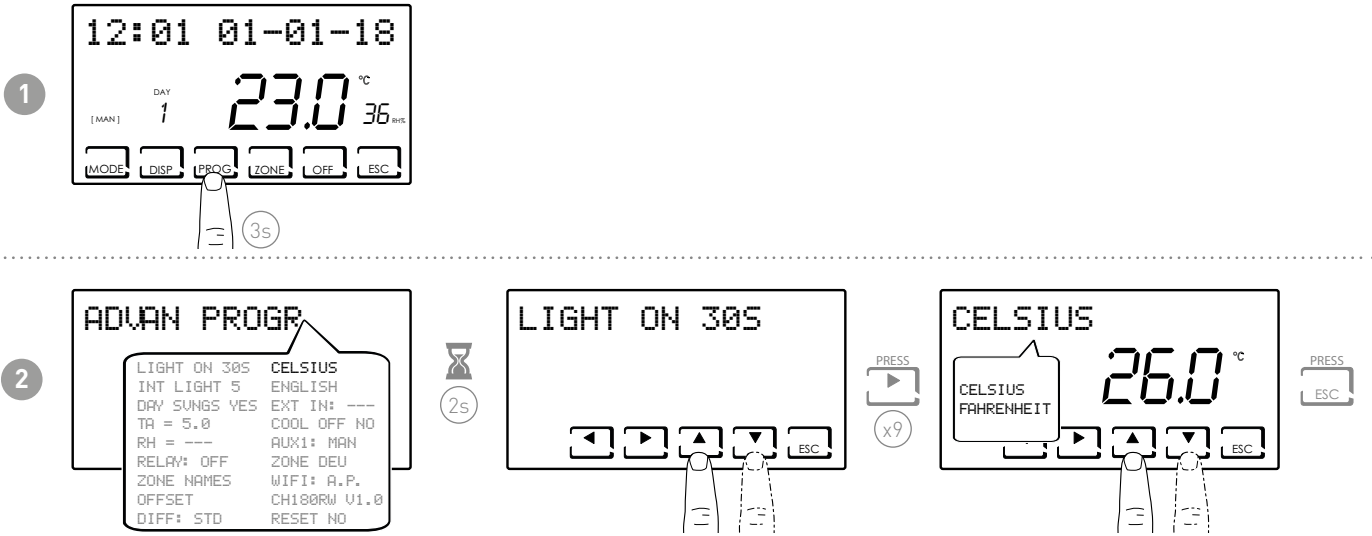

**Note:** the default setting is Celsius.

## 7.11 - LANGUAGE

Allows you to choose which language to use during programming.

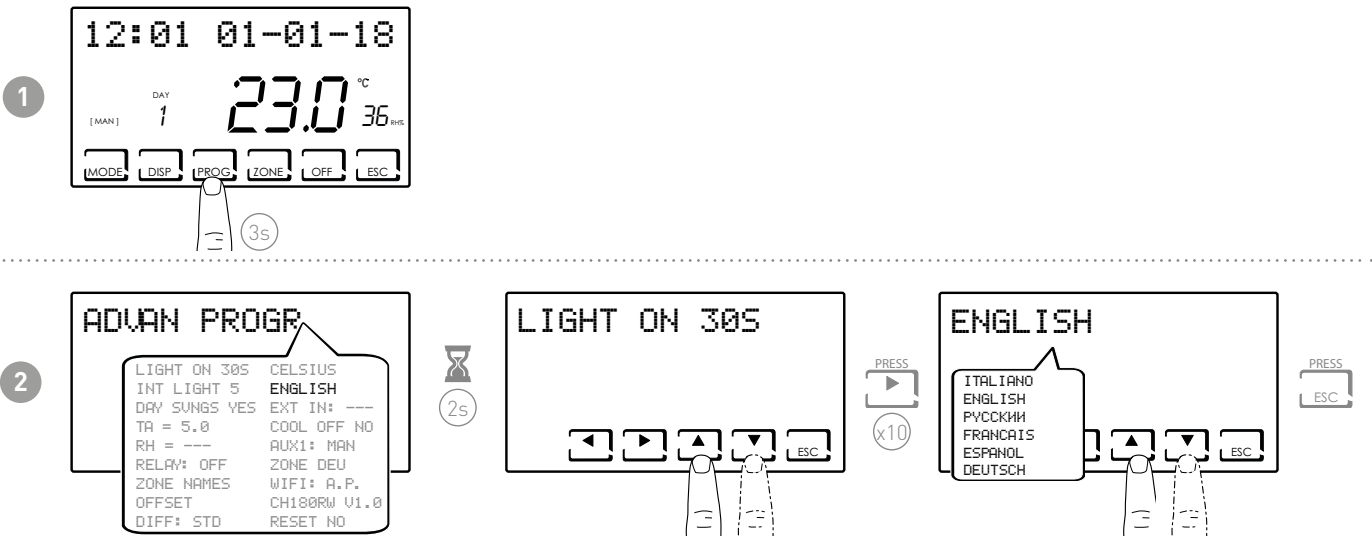

**Note:** the default setting is Italian.

## 7.12 - EXTERNAL PROBE

The CH180RFWIFI does not have an auxiliary input but, inside a multi-one system with at least one CH120RF, it can manage the auxiliary input of the CH120RF itself, if correctly configured (see "ANTI-CONDENSATE ADJUSTMENT" and "EXTERNAL PROBE" in the CH120RF manual).

**Note:** in a multi-zone system only CH120RF associated to zone 2 can be configured with external probe set as remote probe for CH180RFWIFI.

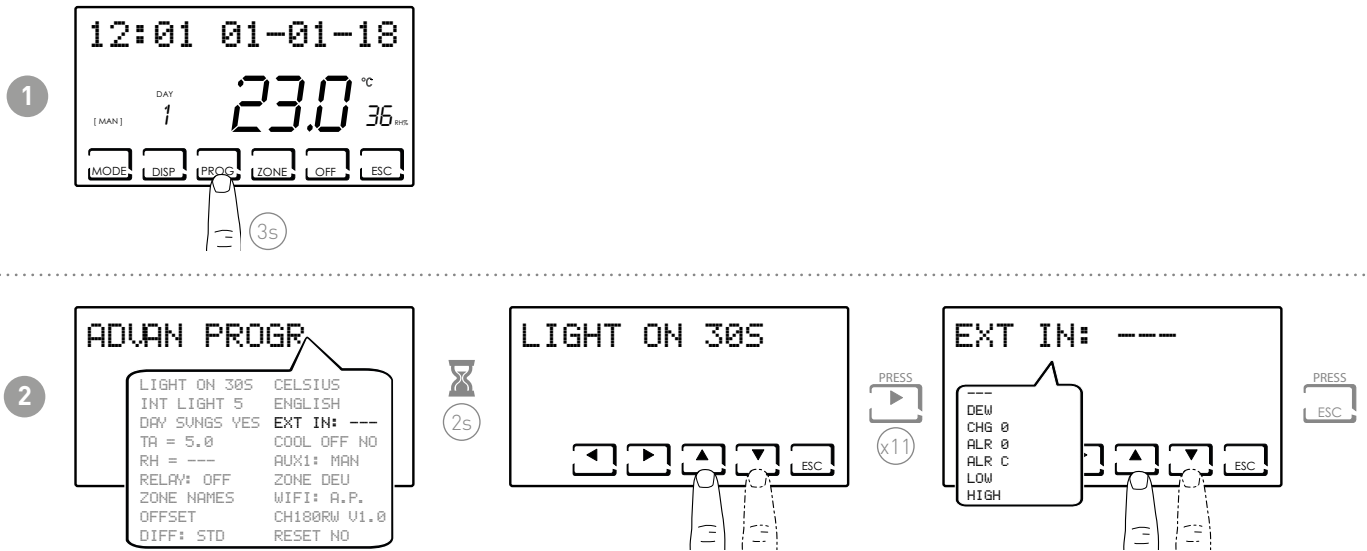

- --- = action disabled

Connecting to CH120RF you can use the following functions after connecting an EC18-EC19-EC20 temperature probe:

- DEW = floor system condensate formation control in summer through control of the dew point (a floor probe is required).  
**Note:** with the control active, when a zone switches the cooling system off, the symbol ❄️ flashes in the corresponding zone.
- LOW = minimum safety temperature exceeded alarm. This is a safety threshold, only active in the SUMMER season and disables the system. To activate, press OK and set the desired minimum threshold using the ▲ or ▼ keys.
- HIGH = maximum safety temperature exceeded alarm. This is a safety threshold, only active in the WINTER season and disables the system. To activate, press OK and set the desired minimum threshold using the ▲ or ▼ keys.

Connecting to CH120RF a voltage-free contact allows you to use the following functions:

- CHG 0 = switch-over to SUMMER mode with closed contact and WINTER mode with open contact
- ALR 0 = display of alarm message in presence of open contact
- ALR C = display of alarm message in presence of closed contact

## 7.13 - COOL OFF

Allows you to control floor system condensate formation in SUMMER without having a floor probe.

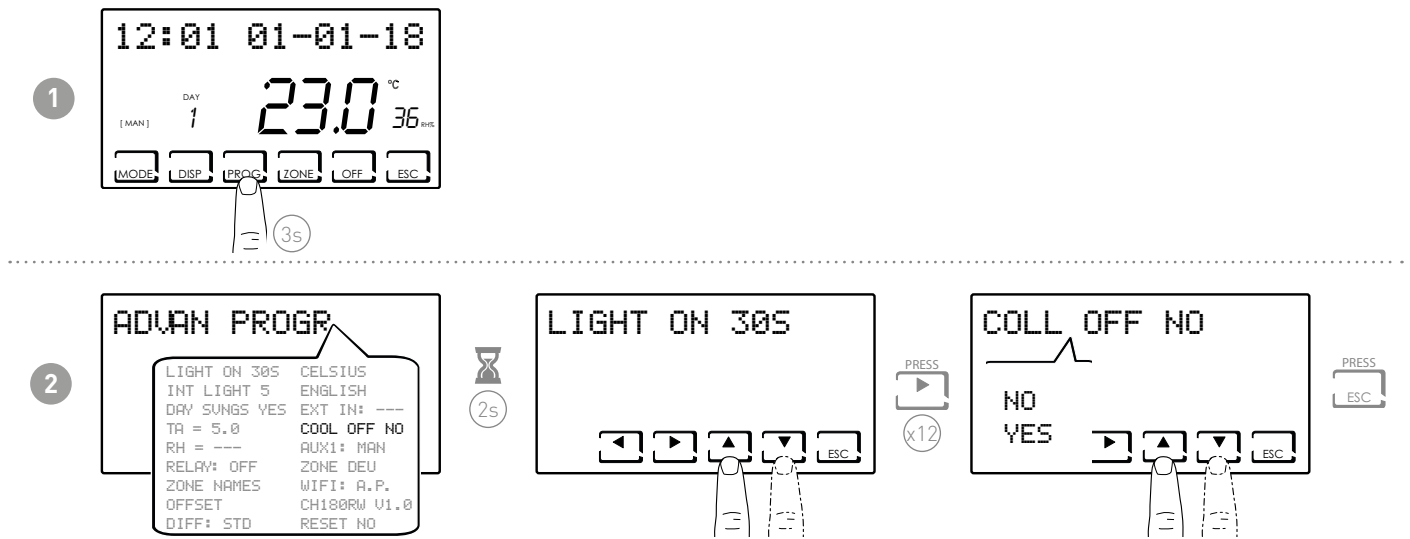

If COOL OFF = YES, the CH180RFWIFI controls cooling system shut-down at the same time as dehumidifier activation (it is necessary to set a RH% threshold and the DEW function must be disabled).

**Note:** with the control active, when a zone switches the cooling system off, the symbol ☀ flashes in the corresponding zone.

## 7.14 - AUX1

This parameter allows to operate the relay of CH175 associated to the programmable thermostat in different modes. The following functions are available:

- PROG = sets the on/off time profile of an external utility (e.g. irrigation, yard light, etc.) in a 24-hour span;
- MAN = sets relay2 in manual/ ON-OFF mode, activated locally by USER PROG (see paragraph 3.4).

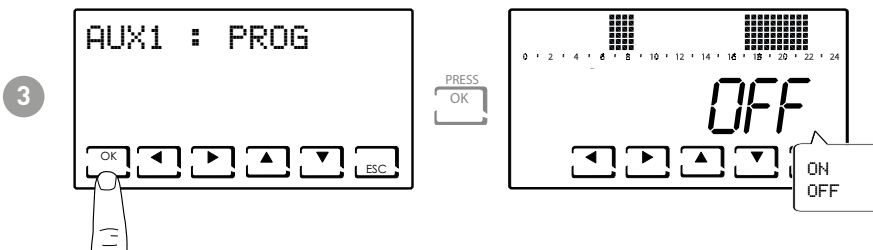
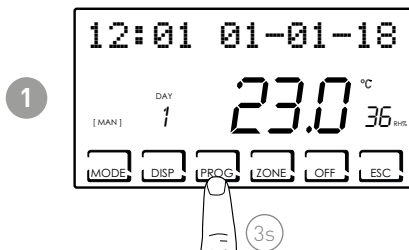

Pressing ◀ or ▶ allows you to scroll the different time bands.  
 Press the ▲ or ▼ arrows to switch AUX1 relay on/off.

**Note:** CH175 in AUX 1 mode can only be associated to the programmable thermostat CH180RFWIFI and must be configured as auxiliary actuator AUX 1.



## 7.15 - ZONE DEU

Allows to associate the zone groups (consisting of CH180RFWIFI and CH120RF) to a dehumidifier/VMC connected to a CH175. There can be 2 groups:

- DEU A GROUP;
- DEU B GROUP

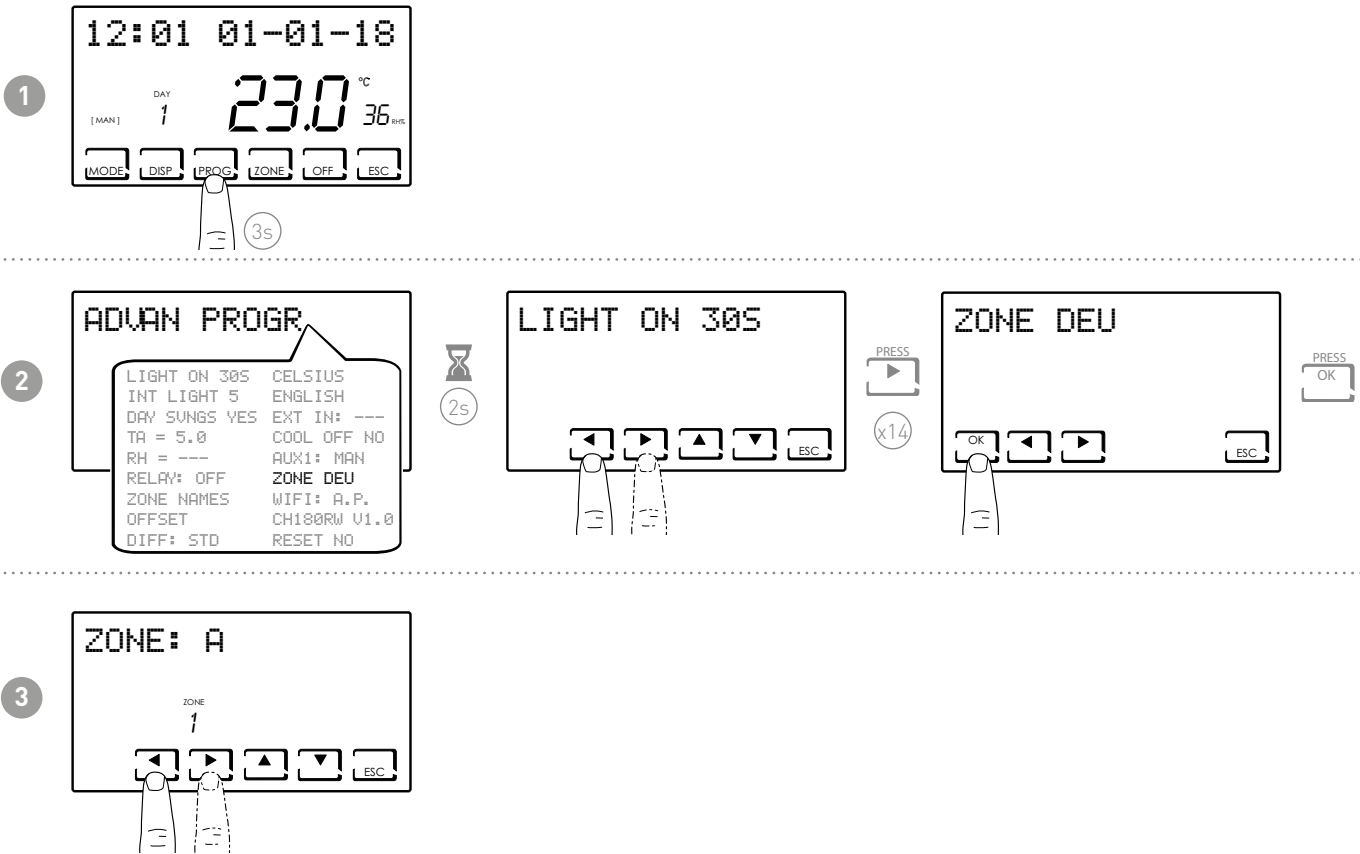

The keys ◀ or ▶ allow you to scroll the zones in CH180RFWIFI.

The ▲ or ▼ arrows associate the DEU A, DEU B group or---for each zone displayed.

**Note:** Only the zones with CH180RFWIFI and CH120RF are displayed.

CH175 in DEU ZONE A or in DEU ZONE B can only be associated with programmable thermostat CH180RFWIFI and must be configured as auxiliary actuator DEU ZONE A or DEU ZONE B.

## 7.16 - WIFI

Displays device WiFi connection status.

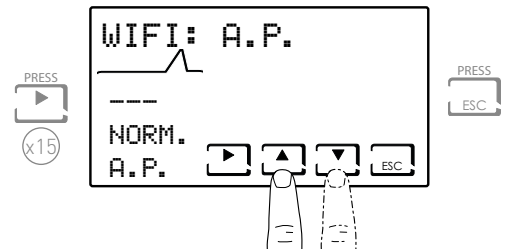
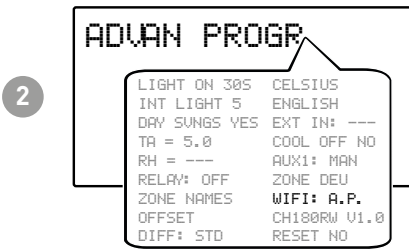
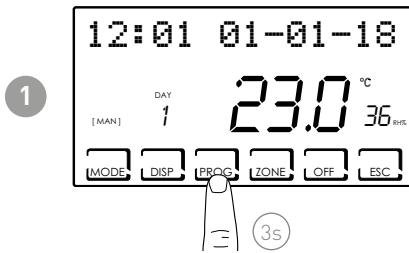

- --- = off
- NORM. = normal
- A.P. = access point (allows you to connect a smartphone)

## 7.17 - INFORMATION

Displays the software version of the programmable thermostat.

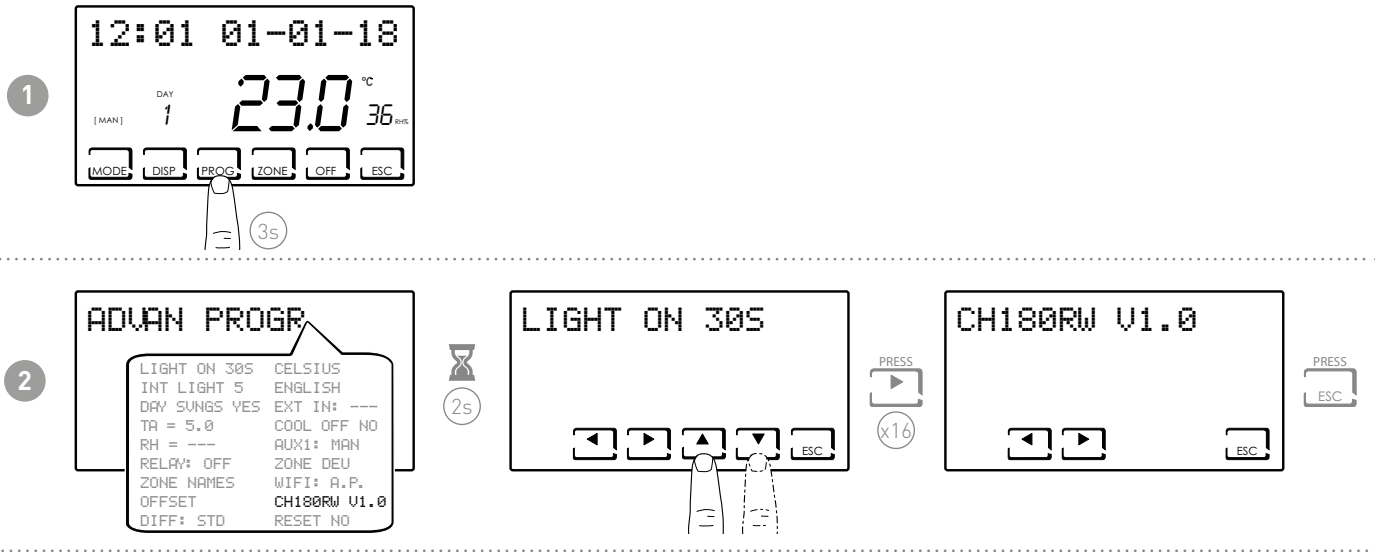

## 7.18 - RESETTING DEFAULT PARAMETERS

Allows you to reset all parameters (except the date and time) to the factory settings.

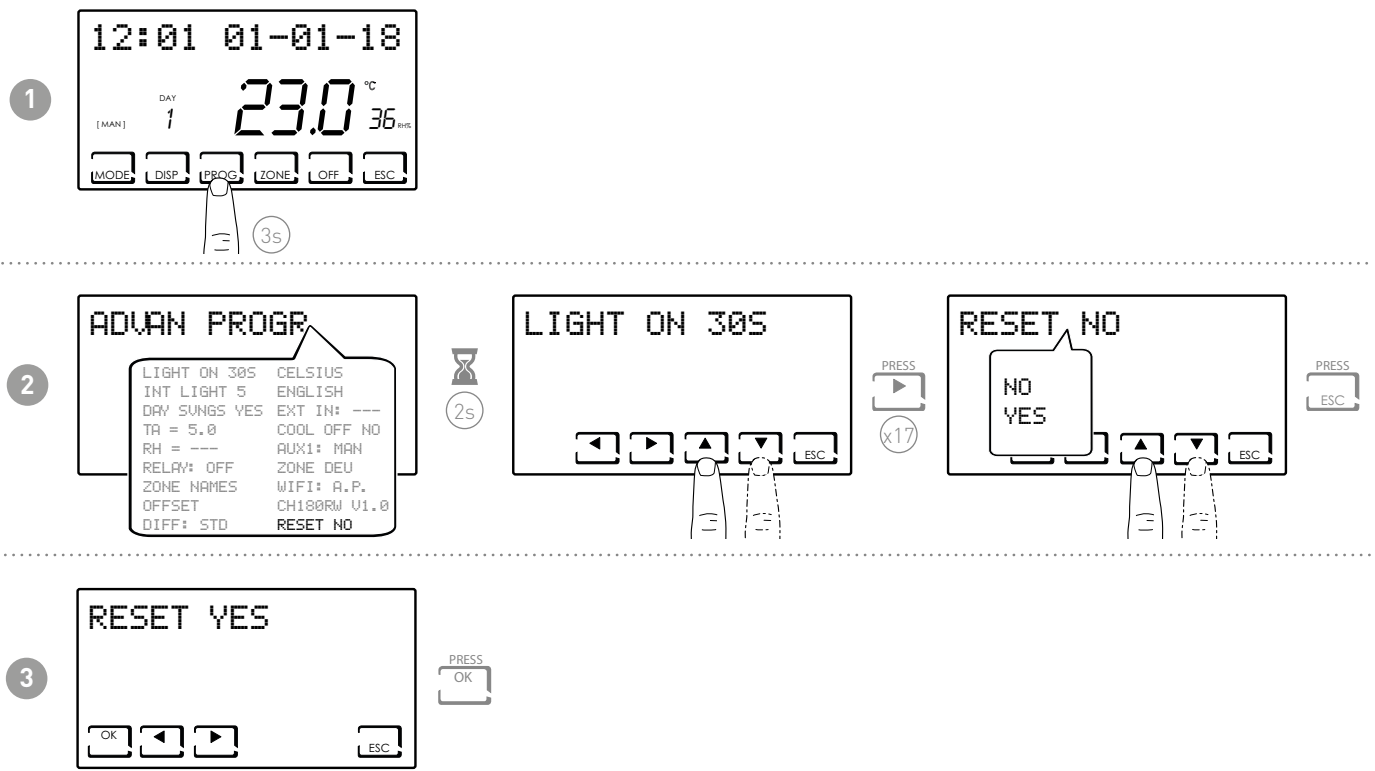

## 8 - REMOTE PROGRAMMING VIA APP

The WiFi signal on the programmable thermostat allows you to remotely control the device via the **IntelliClima+** app, available free of charge from the Google Play Store and Apple App Store.



IntelliClima+



### 8.1 - WIFI ACTIVATION

The programmable thermostat WiFi connection is off upon first start-up. To activate it, go to **ADVANCED PROGRAMMING** and follow the instructions.

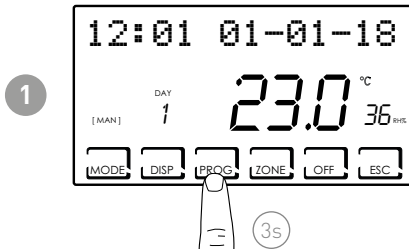

- --- = off
- NORM. = normal
- A.P. = access point (allows you to connect a smartphone)

Select A.P. and press ESC.

Start up the guided installation procedure on the app as described in the "INSTALLATION PROCEDURE" paragraph.

## 8.2 - INSTALLATION PROCEDURE



1



Install the app and, upon first activation, create an account by entering a user name and password.

2



Create a new house by pressing the  key. Enter the desired name and press .

3

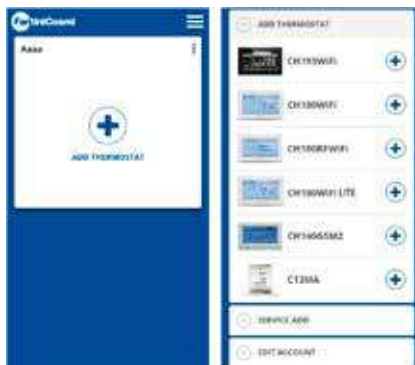

Add the programmable thermostat by pressing the  key and select CH180RFWIFI.

4



At the end of this procedure, the new programmable thermostat will be displayed inside the home.

## 8.3 - CONNECTION PROBLEMS

If the router does not connect to the server:

1. Check that the router password is correct, repeating the steps in paragraphs 8.1 and 8.2;
2. Check that the router supports standard 802.11 b/g/n;
3. Contact your Internet provider and have port 1080 opened at the IP address of the server: 92.48.107.8

## 9 - DISPOSAL



The symbol of the crossed-out wheeled bin indicates that the products must be collected and disposed of separately from household waste. The batteries and integrated accumulators may be disposed of together with the product. They will be separated at the recycling facilities. A black bar indicates that the product was placed on the market after August 13th, 2005. Participating in the separate collection of products and batteries contributes to the correct disposal of these materials and therefore avoids possible negative consequences for the environment and human health. For more detailed information on the collection and recycling programmes available in your country, contact the local authorities or the sales point where you purchased the product.

## 10 - GENERAL WARRANTY CONDITIONS

The conventional warranty lasts 24 months, starting from the date the equipment is installed. The warranty covers all parts of the equipment, with the exception of those subjected to normal wear.

EAC CE

EN79898A-06/2019



**FANTINI COSMI S.p.A.**  
Via dell'Osio, 6 20090 Caleppio di Settala, Milano - ITALY  
Tel. +39 02 956821 | Fax +39 02 95307006 | [info@fantinicosmi.it](mailto:info@fantinicosmi.it)  
[www.fantinicosmi.it](http://www.fantinicosmi.it)